

AVR 1700, AVR 170, AVR 170/230C

Audio/video receiver

Owner's Manual



harman/kardon
by HARMAN

INTRODUCTION	3	SET UP THE AVR	17
SUPPLIED ACCESSORIES	3	TURN ON THE AVR	17
IMPORTANT SAFETY INFORMATION	3	USING THE ON-SCREEN MENU SYSTEM	17
PLACE THE AVR	3	CONFIGURE THE AVR FOR YOUR SPEAKERS	17
FRONT-PANEL CONTROLS	4	ASSIGN THE AVR INPUT CONNECTORS	18
REAR-PANEL CONNECTORS	6	SET UP THE NETWORK	18
SYSTEM REMOTE CONTROL FUNCTIONS	8	ADDITIONAL SOURCE SETUP MENU ITEMS	19
INTRODUCTION TO HOME THEATER	10	OPERATING YOUR AVR	19
TYPICAL HOME THEATER SYSTEM	10	CONTROLLING THE VOLUME	19
MULTICHANNEL AUDIO	10	MUTING THE SOUND	19
SURROUND MODES	10	LISTENING THROUGH HEADPHONES	19
PLACE YOUR SPEAKERS	10	SELECTING A SOURCE	19
PLACING THE LEFT, CENTER AND RIGHT SPEAKERS	10	VIDEO TROUBLESHOOTING TIPS	19
PLACING THE SURROUND SPEAKERS	10	LISTENING TO FM AND AM RADIO	20
PLACING THE SUBWOOFER	10	LISTENING TO INTERNET RADIO (vTUNER)	20
TYPES OF HOME THEATER SYSTEM CONNECTIONS	11	LISTENING TO AN iPod/iPhone/iPad DEVICE	20
SPEAKER CONNECTIONS	11	LISTENING TO MEDIA ON A USB DEVICE	20
SUBWOOFER CONNECTIONS	11	LISTENING TO MEDIA VIA YOUR HOME NETWORK	21
SOURCE DEVICE CONNECTIONS	11	LISTENING TO MEDIA VIA AIRPLAY	22
VIDEO CONNECTIONS	12	SELECTING A SURROUND MODE	22
RADIO CONNECTIONS	12	ADVANCED FUNCTIONS	23
USB/iPod PORT	12	AUDIO PROCESSING AND SURROUND SOUND	23
MAKING CONNECTIONS	13	MANUAL SPEAKER SETUP	24
CONNECT YOUR SPEAKERS	13	SYSTEM SETUP	26
CONNECT YOUR SUBWOOFER	13	ADVANCED REMOTE CONTROL PROGRAMMING	26
CONNECT YOUR TV OR VIDEO DISPLAY	13	RECORDING	27
CONNECT YOUR AUDIO AND VIDEO SOURCE DEVICES	13	SLEEP TIMER	27
CONNECT TO YOUR HOME NETWORK	15	RESETTING THE REMOTE	27
CONNECT THE RADIO ANTENNAS	15	PROCESSOR RESET	27
CONNECT IR EQUIPMENT	15	MEMORY	27
CONNECT THE TRIGGER OUTPUT	15	TROUBLESHOOTING	28
CONNECT TO AC POWER	16	SPECIFICATIONS	29
SET UP THE REMOTE CONTROL	16	APPENDIX	30
INSTALL THE BATTERIES IN THE REMOTE CONTROL	16		
PROGRAM THE REMOTE TO CONTROL YOUR SOURCE DEVICES AND TV	16		

Introduction

Thank you for choosing this Harman Kardon® product!

For more than fifty years, the Harman Kardon mission has been to share a passion for music and entertainment, using leading-edge technology to achieve premium performance. Sidney Harman and Bernard Kardon invented the receiver, a single component designed to simplify home entertainment without compromising performance. Over the years, Harman Kardon products have become easier to use while offering more features and sounding better than ever.

The AVR 1700, AVR 170 and AVR 170/230C 5.1-channel digital audio/video receivers (AVRs) continue this tradition with some of the most advanced audio and video processing capabilities yet and a wealth of listening and viewing options.

To obtain the maximum enjoyment from your new AVR, please read this manual and refer back to it as you become more familiar with its features and their operation.

If you have any questions about this product, its installation or its operation, please contact your Harman Kardon retailer or custom installer, or visit our Web site at www.harmankardon.com.

Supplied Accessories

The following accessory items are supplied with your AVR. If any of these items are missing, please contact your Harman Kardon dealer, or Harman Kardon customer service at www.harmankardon.com.

- System remote control
- EzSet/EQ™ microphone
- AM loop antenna
- FM wire antenna
- Three AAA batteries
- AC power cord

IMPORTANT SAFETY INFORMATION

Verify Line Voltage Before Use

The AVR 1700 has been designed for use with 120-volt alternating current (AC). The AVR 170 and AVR 170/230C have been designed for use with 220 – 240-volt AC. Connection to a line voltage other than that for which your AVR is intended can create a safety and fire hazard, and may damage the unit. If you have any questions about the voltage requirements for your specific model or about the line voltage in your area, contact your selling dealer before plugging the unit into a wall outlet.

Do Not Use Extension Cords

To avoid safety hazards, use only the power cord supplied with your unit. We do not recommend that extension cords be used with this product. As with all electrical devices, do not run power cords under rugs or carpets, or place heavy objects on them. Damaged power cords should be replaced immediately by an authorized service center with a cord meeting factory specifications.

Handle the AC Power Cord Gently

When disconnecting the power cord from an AC outlet, always pull the plug; never pull the cord. If you do not intend to use your AVR for any considerable length of time, disconnect the plug from the AC outlet.

Do Not Open the Cabinet

There are no user-serviceable components inside this product. Opening the cabinet may present a shock hazard, and any modification to the product will void your warranty. If water or any metal object such as a paper clip, wire or staple accidentally falls inside the unit, disconnect it from the AC power source immediately, and consult an authorized service center.

CATV or Antenna Grounding (AVR 1700)

If an outside antenna or cable system is connected to this product, be certain that it is grounded so as to provide some protection against voltage surges and static charges. Section 810 of the United States National Electrical Code, ANSI/NFPA No. 70-1984, provides information with respect to proper grounding of the mast and supporting structure, grounding of the lead-in wire to an antenna discharge unit, size of grounding conductors, location of antenna discharge unit, connection to grounding electrodes and requirements of the grounding electrode.

NOTE TO CATV SYSTEM INSTALLER: This reminder is provided to call the CATV (cable TV) system installer's attention to article 820-40 of the NEC, which provides guidelines for proper grounding and, in particular, specifies that the cable ground shall be connected to the grounding system of the building, as close to the point of cable entry as possible.

Place the AVR

- Place the AVR on a firm and level surface. Be certain that the surface and any mounting hardware can support the AVR's weight.
- Provide proper space above and below the AVR for ventilation. Recommended clearance distances are 30cm above the unit, 30cm behind the unit and 30cm on each side of the unit.
- If you install the AVR in a cabinet or other enclosed area, provide cooling air within the cabinet. Under some circumstances, a fan may be required.
- Do not obstruct the ventilation slots on the top of the AVR or place objects directly over them.
- Do not place the AVR directly on a carpeted surface.
- Do not place the AVR in moist or humid locations, in extremely hot or cold locations, in areas near heaters or heat registers, or in direct sunlight.

Front-Panel Controls

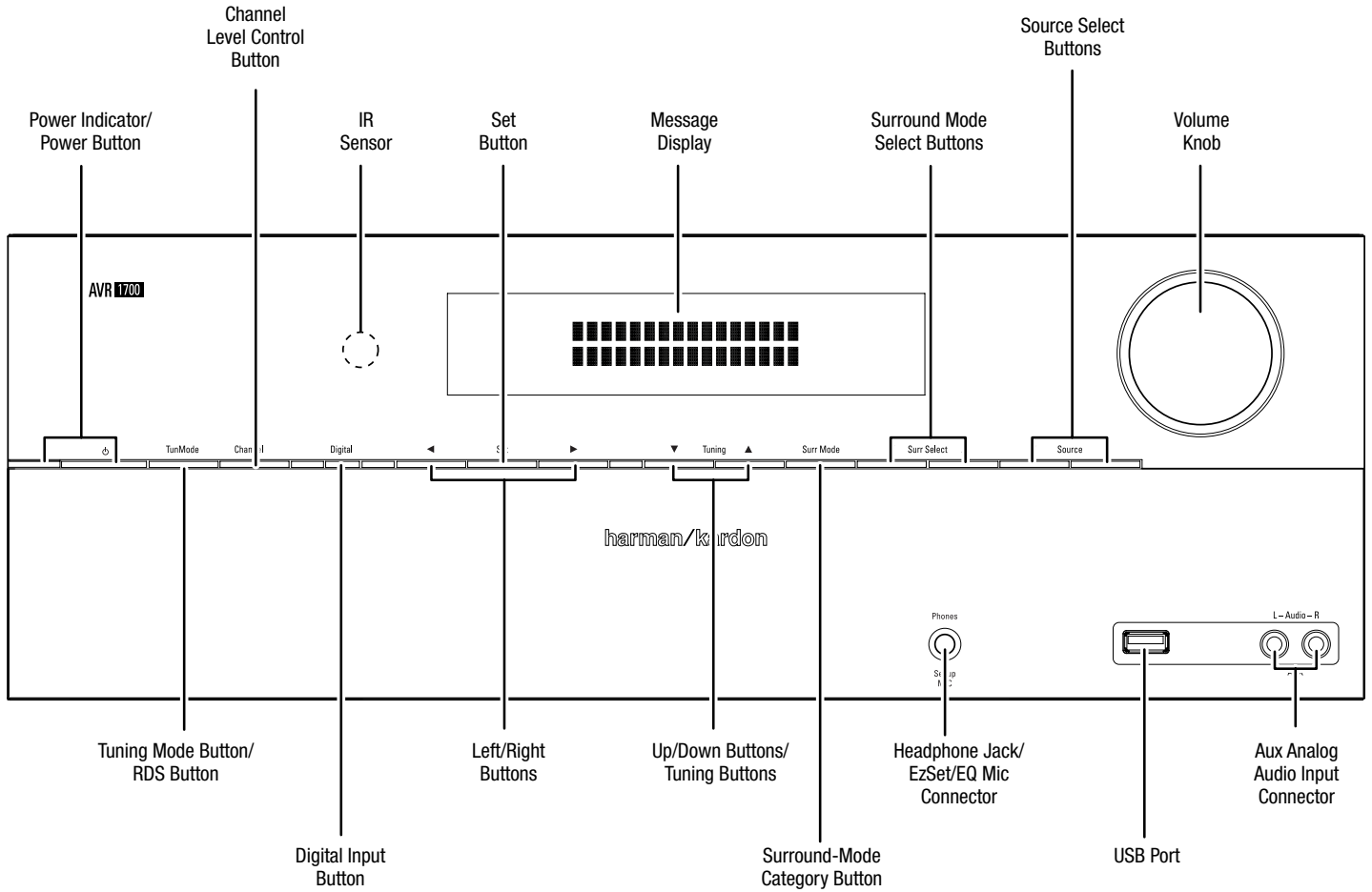

Front-Panel Controls, continued

Power indicator/Power button: The AVR has four different power modes:

- **Off (Power indicator not illuminated):** When the rear-panel Main Power switch is in the Off position or the power cord is unplugged the AVR is off and will not respond to any commands. Plugging the power cord into a live AC outlet and setting the Main Power switch in the On position will put the AVR into the Eco Standby mode.
- **Eco Standby (Power indicator glows solid amber):** The Eco Standby mode minimizes energy consumption when you're not using the AVR. When the AVR is in Eco Standby, it will not automatically turn on or play audio in response to an AirPlay signal from a networked device. When the AVR is in Eco Standby, pressing the Power button turns it on. To put the AVR into Eco Standby when it is on, press the Power button for more than three seconds. **NOTE: The AVR will not automatically enter the Eco Standby mode.**
- **Standby (Power indicator glows solid amber):** The Standby mode mutes the AVR and shuts off its front-panel display, but allows the AVR to automatically turn on and play audio in response to an AirPlay signal from a networked device. See *Listening to Media via AirPlay*, on page 22, for more information. When the AVR is in Standby, pressing the Power button turns it on. To put the AVR into Standby when it is on, press the Power button for less than three seconds. **NOTE: The AVR will automatically enter the Standby mode whenever no control buttons have been pressed and no audio signal has been present for 30 minutes.**
- **On (Power indicator glows solid white):** When the AVR is on it is fully operational.

IMPORTANT NOTE: If the PROTECT message ever appears on the AVR's front-panel Message display, turn off the AVR and unplug it from the AC outlet. Check all speaker wires for a possible short circuit (the "+" and "-" conductors touching each other or both touching the same piece of metal). If a short circuit is not found, bring the unit to an authorized Harman Kardon service center for inspection and repair before using it again.

Tuning Mode button (AVR 1700 only): This button toggles between manual (one frequency step at a time) and automatic (seeks frequencies with acceptable signal strength) tuning mode. It also toggles between stereo and mono modes when an FM station is tuned in.

RDS button (AVR 170 only): When listening to an FM radio station that broadcasts RDS information, this button activates the various RDS functions. **NOTE:** RDS service may not be available in all areas.

Channel Level Control button: Press this button to activate the channel-level adjustment feature. After pressing this button, use the Up/Down buttons to select the channel for adjustment and use the Left/Right buttons to adjust the channel's level.

Digital Input button: Press this button to change the audio input for the current source. Use the Left/Right buttons to cycle through the available input connections, and press the Set button to assign the currently-displayed connection to the source.

IR sensor: This sensor receives infrared (IR) commands from the remote control. It is important to ensure that the sensor is not blocked.

Set button: Press this button to select the currently highlighted menu item.

Left/Right buttons: Use these buttons to navigate the AVR's menus.

Message display: Various messages appear in this two-line display in response to commands and changes in the incoming signal. In normal operation, the current source name appears on the upper line, while the surround mode is displayed on the lower line. When the on-screen display menu system (OSD) is in use, the current menu settings appear.

Up/Down buttons/Tuning buttons: Use these buttons to navigate the AVR's menus. When the radio is the active source, use these buttons to tune stations according to the setting of the Tuning Mode button (see above).

Surround-Mode Category button: Press this button to select a surround-sound category. Each press changes the surround-mode category: Auto Select, Virtual, Stereo, Movie, Music and Video Game. To change the specific surround-sound mode within the category, use the Surround Mode Select buttons. See *Audio Processing and Surround Sound*, on page 23, for more information on surround modes.

Surround-Mode Select buttons: After you have selected the desired surround-mode category, press these buttons to select a specific mode within the category, such as to change from Dolby® Pro Logic® II Movie mode to Logic 7® Movie mode. Surround-mode availability depends on the nature of the source input signal, i.e., digital versus analog, and the number of channels encoded within the signal.

Source Select buttons: Press these buttons to select the active source.

Headphone jack/EzSet/EQ Mic connector: Connect a 1/4" stereo headphone plug to this jack for private listening. This jack is also used to connect the supplied microphone for the EzSet/EQ procedure described in *Configure the AVR for Your Speakers*, on page 17.

USB port: The USB port can be used to play audio files from an Apple iOS® device connected to the port, and can also be used to play MP3 and WMA audio files from a USB device inserted into the port. Insert the connector or device into the USB port oriented so it fits all the way into the port. You may insert or remove the connector or device at any time - there is no installation or ejection procedure.

You can also use the USB port to perform firmware upgrades. If an upgrade for the AVR's operating system is released in the future, you will be able to download it to the AVR using this port. Complete instructions will be provided at that time.

IMPORTANT: Do not connect a PC or other USB host/controller to this port, or you may damage both the AVR and the other device. HDD is not supported.

Volume knob: Turn this knob to raise or lower the volume.

Aux Analog Audio Input connector: Connect an auxiliary source component that will be used only temporarily, such as a camcorder, portable music player or game console, here.

Rear-Panel Connectors

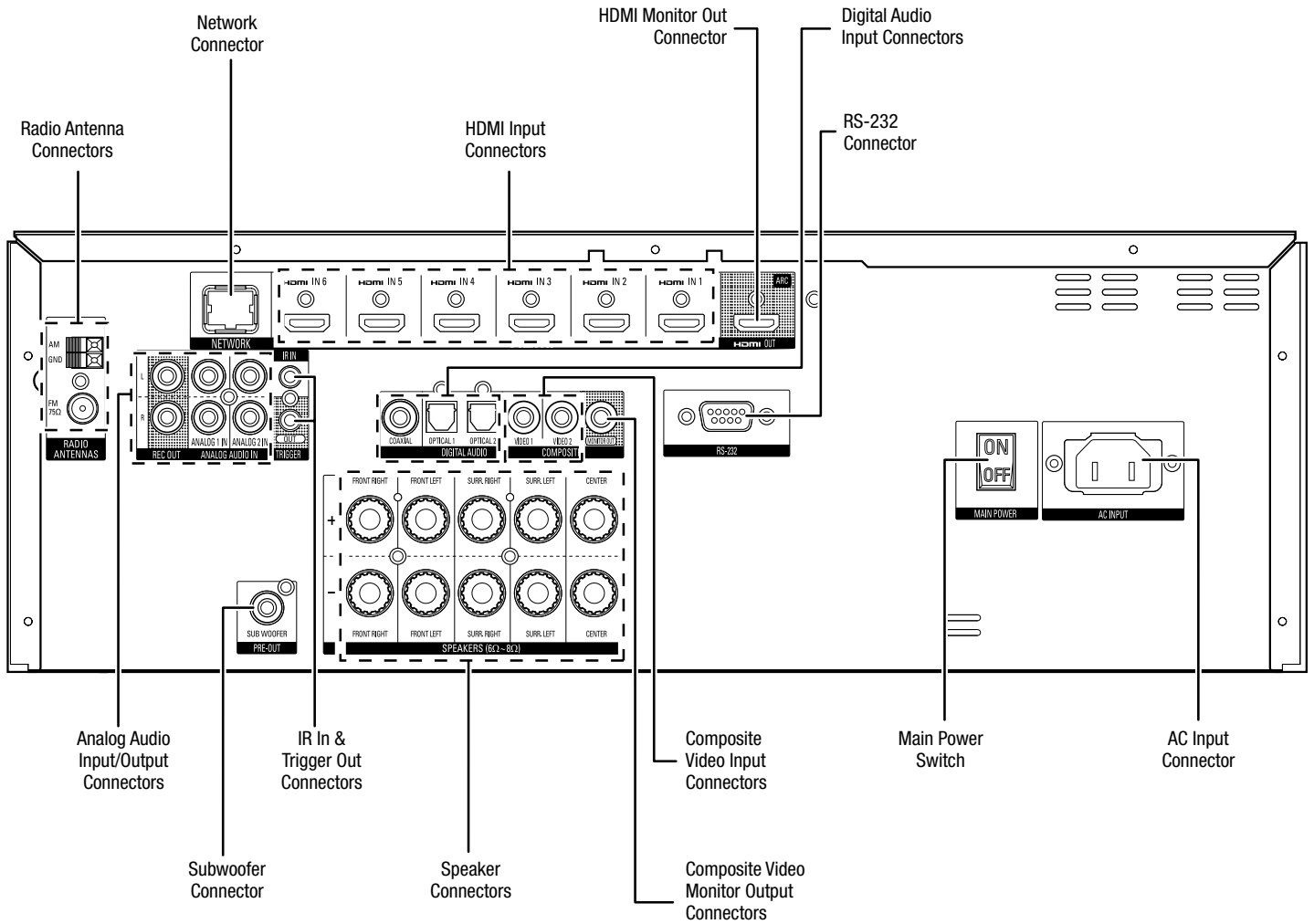

Rear-Panel Connectors, continued

Radio Antenna connectors: Connect the included AM and FM antennas to their respective terminals for radio reception.

Analog Audio Input/Output connectors: Use the AVR's Analog Audio Input/Output connectors for source devices that don't have HDMI or digital audio connectors. Use the Rec Out connectors to connect to the audio inputs of a VCR or tape deck. See *Connect Your Audio and Video Source Devices*, on page 13, for more information.

Network connector: Use a Cat. 5 or Cat. 5E cable (not supplied) to connect the AVR's Network connector to your home network to enjoy Internet radio and content from DLNA-compatible devices that are joined to the network. See *Connect to Your Home Network*, on page 15, for more information.

Subwoofer connector: Connect this jack to a powered subwoofer with a line-level input. See *Connect Your Subwoofer*, on page 13, for more information.

IR In and Trigger Out connectors: When the IR sensor on the front panel is blocked (such as when the AVR is installed inside a cabinet), connect an optional IR receiver to the IR In jack. The Trigger Out connector provides 12V DC whenever the AVR is on. Connect it to the trigger input of a device such as a powered subwoofer.

Speaker connectors: Use two-conductor speaker wire to connect each set of terminals to the correct speaker. See *Connect Your Speakers*, on page 13, for more information.

HDMI® Input connectors: The HDMI (High-Definition Multimedia Interface) feature is a connection for transmitting digital audio and video signals between devices. If your source devices have HDMI connectors, using them will provide the best possible video and audio performance quality. Since the HDMI cable carries both digital video and digital audio signals, you do not have to make any additional audio connections for devices you connect via HDMI connections. See *Connect Your Audio and Video Source Devices*, on page 13, for more information.

HDMI Monitor Out connector: If your TV has an HDMI connector and you have HDMI source devices, use an HDMI cable (not included) to connect it to the AVR's HDMI Monitor Out connector.

Notes on using the HDMI Monitor Out connector:

- When connecting a DVI-equipped display to the HDMI Monitor Out connector, use an HDMI-to-DVI adapter and make a separate audio connection.
- Make sure the HDMI-equipped display is HDCP-compliant. If it isn't, do not connect it via HDMI; use a composite analog video connection instead and make a separate audio connection.

Composite Video Input connectors: Use composite video connectors for video source devices that don't have HDMI or component video connectors. You will also need to make an audio connection from the source device to the AVR. See *Connect Your Audio and Video Source Devices*, on page 13, for more information.

Composite Video Monitor Output connector: If your TV or video display does not have an HDMI connector, or if your TV does have an HDMI connector *but you are connecting some source devices with only composite video connectors*, use a composite video cable (not included) to connect the AVR's Composite Video Monitor Out connector to your TV's composite video input connector.

Digital Audio Input connectors: If your non-HDMI source devices have digital outputs, connect them to the AVR's digital audio connectors. NOTE: Make only one type of digital connection (HDMI, optical or coaxial) from each device. See *Connect Your Audio and Video Source Devices*, on page 13, for more information.

RS-232 connector: This connector is used to connect to external control hardware. Consult a certified professional installer for more information.

Main Power switch: This mechanical switch turns the AVR's power supply on or off. It is usually left on and cannot be turned on or off using the remote control.

AC Input connector: After you have made all other connections, plug the supplied AC power cord into this receptacle and into an unswitched wall outlet.

System Remote Control Functions

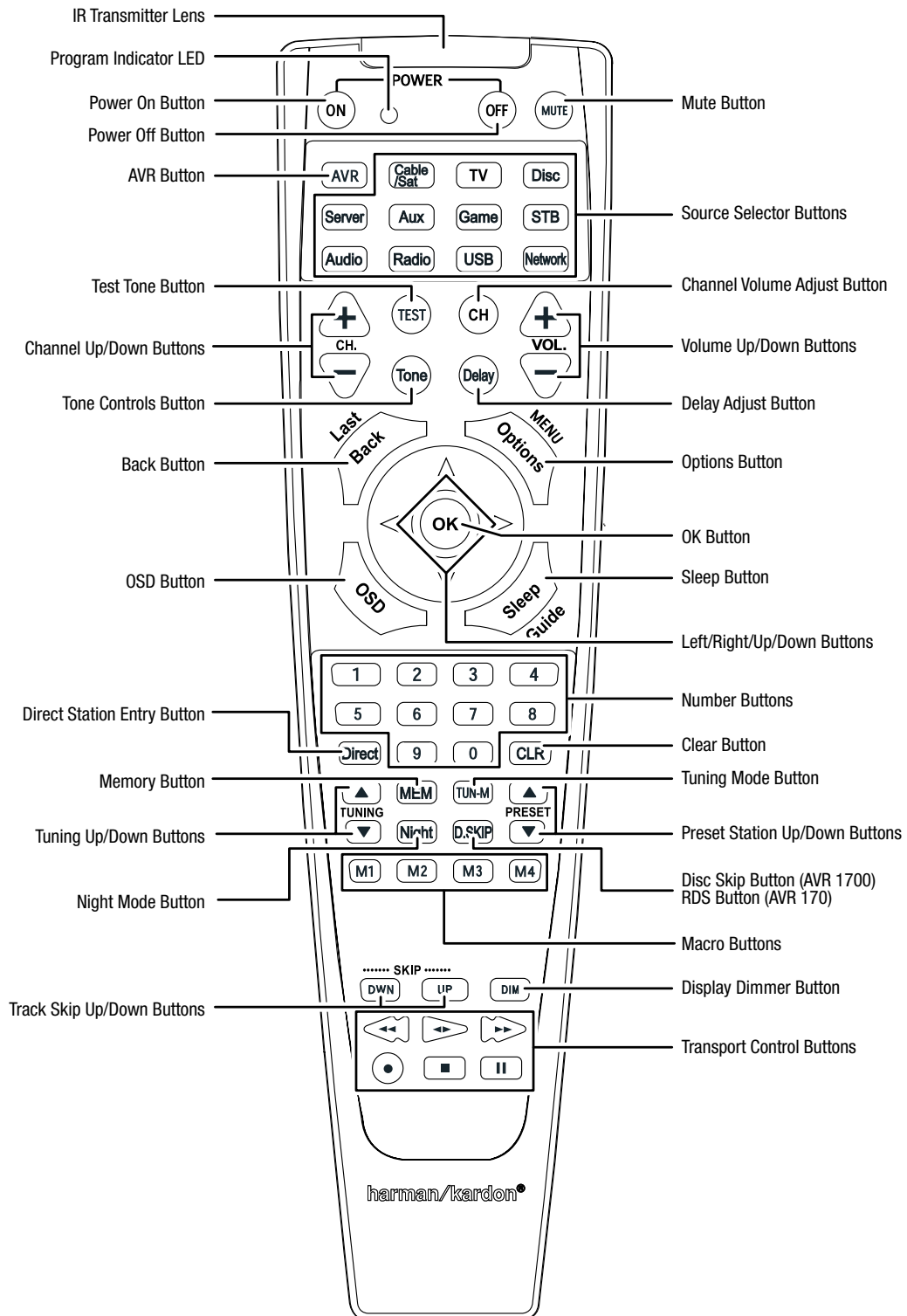

System Remote Control Functions, continued

In addition to controlling the AVR, the AVR remote is capable of controlling five other devices, plus your TV and an iPod/iPhone that is docked in the AVR's front-panel USB port. During the installation process, you may program the codes for each of your source components into the remote. (See *Program the Remote to Control Your Source Devices and TV*, on page 16, for programming information.) To operate a component, press its Source Selector button to change the remote's control mode.

A button's function depends on which component is being controlled. See Table A9 in the Appendix for listings of the functions for each type of component. Most of the buttons on the remote have dedicated functions, although the precise codes transmitted vary depending on the specific device being controlled. Due to the wide variety of functions for various source devices, we have included only a few of the most often-used functions on the remote: alphanumeric keys, transport controls, television-channel control, menu access and power on and off. To return the remote to the AVR control mode at any time, press the AVR button.

IR Transmitter lens: As buttons are pressed on the remote, infrared codes are emitted through this lens.

Program Indicator LED: This LED lights up to indicate various procedures when the remote is in the Programming mode.

Power On/Off buttons: Press these buttons to turn the AVR or the device being controlled on and off. The Main Power switch on the AVR's rear panel must be on for this button to turn the AVR on and off.

NOTE: When the AVR is on, pressing the Power Off button for more than three seconds will put it into the Eco Standby mode. See *Power indicator/Power button*, on page 5 for more information.

Mute button: Press this button to mute the AVR's speaker-output connectors and Headphone jack. To restore the sound, press this button or adjust the volume.

AVR button: Press this button to switch the remote's control mode to operate the AVR.

Source Selector buttons: Press one of these buttons to select a source device, e.g., cable/satellite tuner, radio, etc. This action will also turn on the AVR and switch the remote's control mode to operate the selected source device.

- The first press of the Radio Source Selector button switches the AVR to the last-used tuner band (AM or FM). Each successive press changes the band.
- The first press of the USB button switches the AVR to the last-used source (USB or iPod). Each successive press cycles between the two source.
- The first press of the Network button switches the AVR to the last-used source (Network or vTuner). Each successive press cycles between the two sources.

Test Tone button: Press this button to activate the test tone for calibrating channel volume levels by ear.

Channel Volume Adjust button: Press this button to activate the individual channel-level adjustment. It lets you easily change the channel balance to suit different programs or seating arrangements. See *Manual Speaker Setup*, on page 24, for more information.

Channel Up/Down buttons: The Channel Up/Down buttons have no effect on the AVR but are used to change channels on TVs and some video sources.

Volume Up/Down buttons: Press these buttons to raise or lower the volume.

Tone Controls button: Press this button to access the bass and treble controls. Use the OK button to select an adjustment and use the Up/Down buttons to change the settings.

Delay Adjust button: Pressing this button lets you adjust two different types of delay settings (use the Up/Down buttons to cycle through the settings):

- A/V Sync: This setting lets you resynchronize the audio and video signals from a source to eliminate a "lip sync" problem. Lip-sync issues can occur when the video portion of a signal undergoes additional processing in either the source device or the video display. Use the Left/Right buttons to delay the audio by up to 180ms.
- Front L/Center/Front R/Surr R/Surr L/Subwoofer: These settings let you set the delay for each speaker to compensate for the different distances they may be from the listening position. Use the Up/Down buttons to cycle through each of the system's speakers, and use the Left/Right buttons to set the distance each speaker is from the listening position. See *Manual Speaker Setup*, on page 24, for more information.

Back button: Press this button to return to the previous menu screen when you're using the on-screen menu (OSD) system.

Options button: This button allows you to adjust playback and various other options for the AVR's built-in sources and when controlling other components.

OSD button: Press this button to activate the on-screen display menu system.

OK button: This button is used to select items from the menu system.

Sleep button: Press this button to activate the sleep timer, which turns off the AVR after a programmed period of time (up to 90 minutes).

Left/Right/Up/Down buttons: These buttons are used to navigate the menu system.

Number buttons: Use these buttons to enter numbers for radio-station frequencies or to select station presets.

Direct Station Entry button: Press this button before using the Number buttons to enter a radio station frequency.

Clear button: Press this button to clear a radio station frequency you have started to enter.

Memory button: To save the currently tuned radio station as a preset, press this button, then a Number button.

Tuning Mode button: Press this button to toggle the radio between manual (one frequency step at a time) and automatic (seeks frequencies with acceptable signal strength) tuning mode. It also toggles between stereo and mono modes when an FM station is tuned in.

Tuning Up/Down buttons: Press these buttons to tune a radio station. Depending on whether the tuning mode has been set to manual or automatic, each press will either change one tuning frequency increment at a time or seek the next higher or lower station with acceptable signal strength.

Preset Station Up/Down buttons: Press these buttons to cycle through your preset radio stations.

Night Mode button: Press this button to activate Night mode with specially encoded Dolby Digital discs or broadcasts. Night mode compresses the audio so that louder passages are reduced in volume to avoid disturbing others, while dialogue remains intelligible. Each press of the button advances through the following settings:

- Off: No compression is applied. Loud passages in the program remain as they were recorded.
- Mid: Loud passages in the program are reduced moderately in volume.
- Max: Loud passages in the program are reduced more in volume.

Disc Skip button (AVR 1700): This button is used with some optical disc changers to skip to the next disc.

RDS button (AVR 170): When listening to an FM radio station that broadcasts RDS information, this button activates the various RDS functions.

Macro buttons: These buttons may be programmed to execute a series of up to 19 commands with a single button press. They are useful for programming the command to turn on or off all of your components or for accessing specialized functions for a different component from the one that you are currently operating. See *Programming Macro Commands*, on page 27, for information about programming macros.

Track Skip Up/Down buttons: These buttons are used with the AVR's built-in sources (USB, iPod, Network, AirPlay, etc) and many source components to change tracks or chapters.

Display Dimmer button: Press this button to dim the AVR's front-panel display partially or fully.

Transport Control buttons: These buttons have no effect on the AVR but are used to control many source components. By default, when the remote is operating the AVR, these buttons will control a Harman Kardon Blu-ray Disc™ player or DVD player.

Introduction to Home Theater

This introductory section will help you to familiarize yourself with some basic concepts unique to multichannel surround-sound AVRs, which will make it easier for you to set up and operate your AVR.

Typical Home Theater System

A home theater typically includes an audio/video receiver (AVR), which controls the system and supplies amplification for the loudspeakers; a disc player; a source component for television broadcasts (cable box, satellite dish AVR, HDTV tuner or antenna connected to the TV); a TV or video display; and multiple loudspeakers.

Multichannel Audio

The main benefit of a home theater system is its ability to produce “surround sound.” Surround sound uses multiple speakers and amplifier channels to immerse you in the audio/video presentation for a dramatically increased sense of realism.

Your AVR can have up to five main speakers connected directly to it, plus a subwoofer. Each main speaker is powered by its own amplifier channel inside the AVR. A system with more than two speakers is called a multichannel system. The different main speaker types in a home theater system are:

- **Front Left and Right:** The front left and right speakers are used as in a 2-channel system. In many surround-sound modes, these speakers are secondary, while the main action, especially dialogue, is reproduced by the center speaker.
- **Center:** When you are watching movies and television programs, the center speaker reproduces most of the dialogue and other soundtrack information that occurs on the screen, anchoring it with the picture. When you are listening to a musical program, the center speaker helps to create a seamless front soundstage, creating a more realistic “you-are-there” listening experience.
- **Surround Left and Right:** The surround left and right speakers produce ambient sounds that help create a realistic and immersive surround-sound environment. They also help recreate directional sound effects such as aircraft flyovers.
Many people expect the surround speakers to play as loudly as the front speakers. Although you will calibrate all of the speakers in your system to sound equally loud at the listening position, most artists use the surround speakers for ambient effects only, and they create their programs to steer relatively little sound to these speakers.
- **Subwoofer:** A subwoofer is designed to play only the lowest frequencies (the deep bass). It augments smaller, limited-range main speakers that are usually used for the other channels. Many digital-format programs, such as movies recorded in Dolby Digital, contain a low-frequency effects (LFE) channel that is directed to the subwoofer. The LFE channel packs the punch of a rumbling train or airplane, or the power of an explosion, adding realism and excitement to your home theater. Some people use two subwoofers for additional power and for even distribution of the sound.

Surround Modes

There are different theories as to the best way to present surround sound and to distribute the individual channel information to the surround-sound system’s speakers. A variety of algorithms have been developed in an effort to recreate the way we hear sounds in the real world, resulting in a rich variety of options. Several companies have developed different surround-sound technologies, all of which can be accurately reproduced by your AVR:

- **Dolby Laboratories:** Dolby TrueHD, Dolby Digital Plus, Dolby Digital, Dolby Digital EX, Dolby Pro Logic II.
- **DTS:** DTS-HD™ High Resolution Audio, DTS-HD Master Audio™, DTS, DTS 96/24™, DTS NEO: 6™.
- **HARMAN International:** Logic 7, virtual speaker.
- **Stereo Modes:** 2-channel stereo and 5-channel stereo.

Appendix Table A8, on page 32, contains detailed explanations of the different surround-sound options available on your AVR. Digital surround-sound modes, such as Dolby Digital and DTS systems, are available only with specially encoded programs, such as those available via HDTV, DVD and Blu-ray Disc media and digital cable or satellite television. Other surround modes may be used with digital and analog signals to create a different surround presentation or to use a different number of speakers. Surround-mode selection depends upon the number of speakers in your system, the programs you are watching or listening to, and your personal tastes.

Place Your Speakers

Determine the locations for your system’s speakers according to their manufacturer’s directions and the layout of your listening room. Use the illustration below as a guide for 5.1-channel systems.

To create the most realistic surround-sound environment possible, you should place your speakers in a circle with the listening position at its center. You should angle each speaker so it directly faces the listening position. Use the diagram below as a guide.

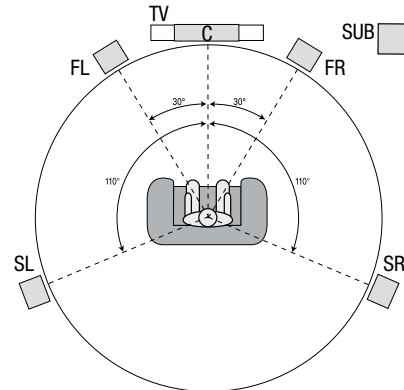

Placing the Left, Center and Right Speakers

Place the center speaker either on top of, below or mounted on the wall above or below the TV or video-display screen. Place the front left and right speakers along the circle, about 30 degrees from the center speaker and angled toward the listener.

Place the front left, front right and center speakers at the same height, preferably at about the same height as the listener’s ears. The center speaker should be no more than 2 feet (0.6m) above or below the left/right speakers. If you’re using only two speakers with your AVR, place them in the front left and front right positions.

Placing the Surround Speakers

You should place the left and right surround speakers approximately 110 degrees from the center speaker, slightly behind and angled toward the listener. Alternatively, you can place them behind the listener, with each surround speaker facing the opposite-side front speaker. You should place the surround speakers 2 feet – 6 feet (0.6m – 1.8m) higher than the listener’s ears.

NOTE: Your AVR will sound its best when the same model or brand of loudspeaker is used for all positions.

Placing the Subwoofer

Because a room’s shape and volume can have a dramatic effect on a subwoofer’s performance, it is best to experiment with placement so that you will find the location that produces the best results in your particular listening room. With that in mind, these rules will help you get started:

- Placing the subwoofer next to a wall generally will increase the amount of bass in the room.
- Placing the subwoofer in a corner generally will maximize the amount of bass in the room.
- In many rooms, placing the subwoofer along the same plane as the left and right speakers can produce the best integration between the sound of the subwoofer and that of the left and right speakers.
- In some rooms, the best performance could even result from placing the subwoofer behind the listening position.

A good way to determine the best location for the subwoofer is by temporarily placing it in the listening position and playing music with strong bass content. Move around to various locations in the room while the system is playing (putting your ears where the subwoofer would be placed), and listen until you find the location where the bass performance is best. Place the subwoofer in that location.

Types of Home Theater System Connections

There are different types of audio and video connections used to connect the AVR to your speakers, your TV or video display, and your source devices. The Consumer Electronics Association has established the CEA® color-coding standard.

Connection Color Guide Table

Analog Audio Connection	Color
Front Left/Right	White/Red
Center	Green
Surround Left/Right	Blue/Gray
Subwoofer	Purple
Digital Audio Connection	Color
Coaxial	Orange
Optical	Black
Analog Video Connection	Color
Composite Video	Yellow

Speaker Connections

Speaker cables carry an amplified signal from the AVR's speaker terminals to each loudspeaker. Each cable contains two wire conductors, or leads, that are differentiated in some way, such as with colors or stripes.

The differentiation helps you maintain proper polarity, without which your system's low-frequency performance can suffer. Each speaker is connected to the AVR's speaker-output terminals using two wires, one positive (+) and one negative (-). Always connect the positive terminal on the speaker, which is usually colored red, to the positive terminal on the AVR, which is colored as indicated in the Connection Color Guide Table, above. The negative terminals on the speakers and the AVR are black.

Your AVR uses binding-post speaker terminals that can accept bare-wire cables or banana plugs. Bare-wire cables are installed as shown below:

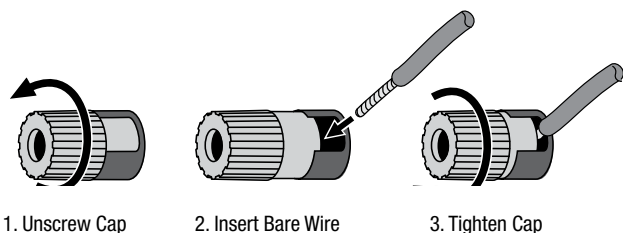

Banana plugs are inserted into the hole in the middle of the terminal cap, as shown below:

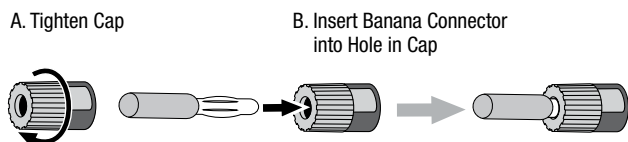

Always connect the colored (+) terminal on the AVR to the (+) terminal on the speaker (usually red), and the black (-) terminal on the AVR to the (-) terminal on the speaker (usually black).

IMPORTANT: Make sure the (+) and (-) bare wires do not touch each other or the other terminal. Touching wires can cause a short circuit that can damage your AVR or amplifier.

Subwoofer Connections

The subwoofer is a speaker dedicated to reproducing only the low (bass) frequencies, which require more power. To obtain the best results, most speaker manufacturers offer powered subwoofers that contain their own amplifiers. Use a single RCA audio cable (not included) to make a line-level (non-amplified) connection from the AVR's Subwoofer connector to a corresponding input jack on the subwoofer.

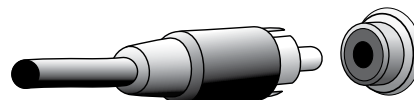

Although the AVR's purple subwoofer output looks similar to a full-range analog audio jack, it is filtered so that only the low frequencies pass through it. Don't connect this output to any device other than a subwoofer.

Source Device Connections

Audio and video signals originate in source devices (components where a playback signal originates) such as your Blu-ray Disc or DVD player, CD player, DVR (digital video recorder) or other recorder, tape deck, game console, cable or satellite television tuner, or a device docked in the AVR's USB port. The AVR's FM/AM tuner also counts as a source, even though no external connectors are needed other than the AVR's FM and AM antennas. Separate connectors are required for the audio and video portions of the source device's signal, except for digital HDMI connectors. The types of connectors you use will depend upon the capabilities of the source device and of your TV or video display.

Digital Audio Connections – HDMI

There are two types of audio connections – digital and analog. Digital audio signals are required for listening to sources encoded with digital surround modes, such as Dolby Digital and DTS, or for uncompressed PCM digital audio. Your AVR has three types of digital audio connectors: HDMI, coaxial and optical. Do not use more than one type of digital audio connector for each source device. However, it's okay to make both analog and digital audio connections to the same source.

Your AVR is equipped with four rear-panel HDMI input connectors and one HDMI monitor output connector. HDMI technology enables digital audio and video information to be carried using a single cable, delivering the highest quality picture and sound. If your TV or video-display device has an HDMI input connector, make a single HDMI connection from each source device to the AVR.

The AVR's HDMI Monitor Output connector contains an Audio Return Channel (ARC) that carries a digital audio signal from your TV or video display back to the AVR. It allows you to listen to HDMI devices that are connected directly to your TV (such as an Internet connection) without making an additional connection from the device to the AVR. The ARC signal is active when the TV source is selected. See *System Setup*, on page 26, for more information.

The HDMI connector is shaped for easy plug-in (see illustration, below), and HDMI cable runs are limited to about 10 feet (3m). If your video display has a DVI input and is HDCP-compliant, use an HDMI-to-DVI adapter (not included), and make a separate audio connection.

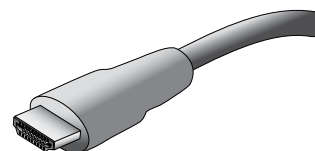

Digital Audio Connections – Coaxial

Coaxial digital audio jacks are usually color-coded orange. Although they look like standard RCA-type analog jacks, you should not connect coaxial digital audio outputs to analog inputs or vice versa.

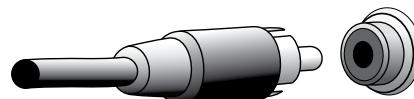

Digital Audio Connections – Optical

Optical digital audio connectors are normally covered by a shutter to protect them from dust. The shutter opens as the cable is inserted. Optical input connectors are color-coded using a black shutter.

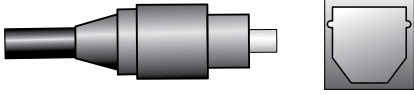

Analog Audio Connections

Two-channel analog connections require a stereo audio cable, with one connector for the left channel (white) and one for the right channel (red). These two connectors are attached to each other.

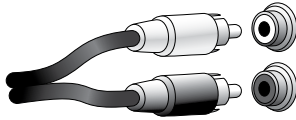

For source devices that have both digital and analog audio outputs, you may make both connections.

Video Connections

Many source devices output both audio and video signals (e.g., Blu-ray Disc, DVD player, cable television box, HDTV tuner, satellite box, VCR, DVR). In addition to an audio connection as described above, make a video connection for each of these source devices. Make only one type of video connection for each device.

Digital Video Connections

If you have already connected a source device to one of the AVR's HDMI input connectors, you have automatically made a video connection for that device, since the HDMI cable carries both digital audio and digital video signals.

Analog Video Connections – Composite Video

Composite video is the basic connection most commonly available. Both the chrominance (color) and the luminance (intensity) components of the video signal are transmitted using a single cable. The jack is usually color-coded yellow and looks like an analog audio jack. Do not connect a composite video jack to an analog audio or coaxial digital audio jack, or vice versa.

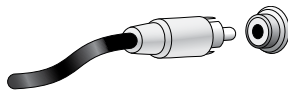

Radio Connections

Your AVR uses separate terminals for the included FM and AM antennas. The FM antenna uses a 75-ohm F-connector.

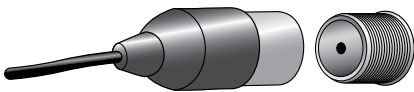

The AM antenna connector uses spring-clip terminals. After assembling the antenna as shown below, press the levers to open the connectors, insert the bare wires into the openings, and release the levers to secure the wires. The antenna wires are not polarized, so you can insert either wire into either connector.

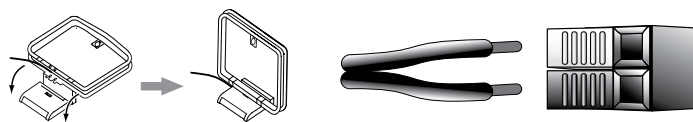

USB Port

The AVR can play audio files from an Apple iOS® device connected to the USB port, and allows you to control the iOS device via the AVR remote control. The AVR can also play MP3 and WMA audio files from a USB device inserted into the USB port. Insert the connector or device into the USB port oriented so it fits all the way into the port. You may insert or remove the connector or device at any time – there is no installation or ejection procedure.

The USB port on your AVR is also used to perform firmware upgrades. If an upgrade for the AVR's operating system is released in the future, you will be able to download it to the AVR using this port. Complete instructions will be provided at that time.

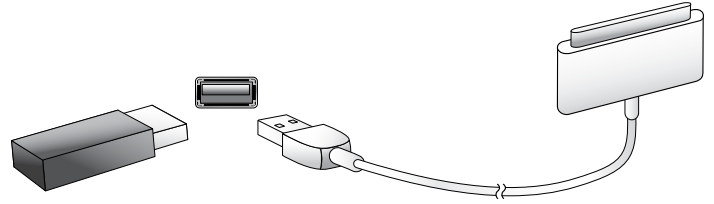

IMPORTANT: Do not connect a PC or other USB host/controller to the AVR's USB port, or you may damage both the AVR and the other device. HDD is not supported.

Making Connections

CAUTION: Before making any connections to the AVR, ensure that the AVR's AC cord is unplugged from the AVR and the AC outlet. Making connections with the AVR plugged in and turned on could damage the speakers.

Connect Your Speakers

After you have placed your loudspeakers in the room as explained in *Place Your Speakers*, on page 10, connect each speaker to its color-coded terminal on the AVR as explained in *Speaker Connections*, on page 11. Connect the speakers as shown in the illustration.

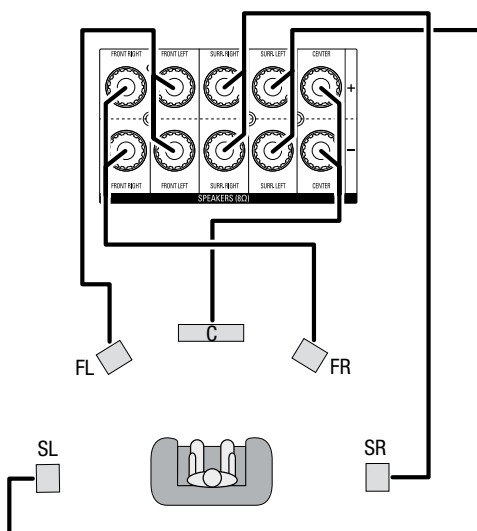

Connect Your Subwoofer

Use a single RCA audio cable to connect the AVR's Subwoofer Pre-Out connector to your subwoofer. Consult your subwoofer's user manual for specific information about making connections to it.

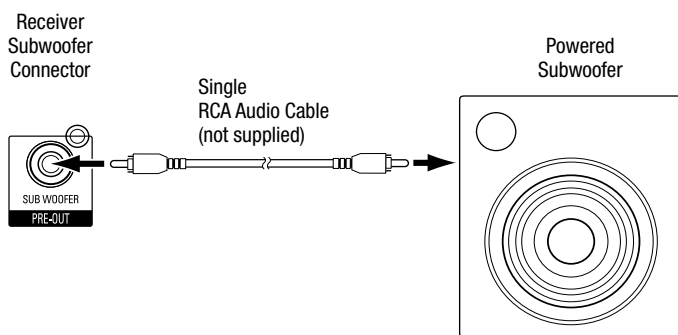

Connect Your TV or Video Display

HDMI Monitor Out connector

If your TV has an HDMI connector and you have HDMI or component video source devices, use an HDMI cable (not included) to connect your TV to the AVR's HDMI Monitor Out connector. It will provide the best possible picture quality.

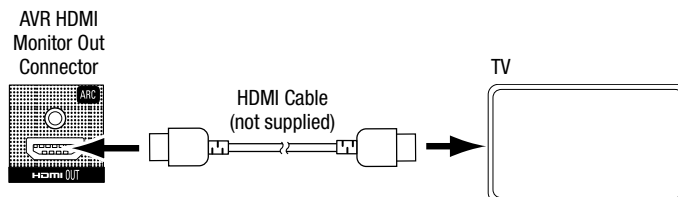

Composite Video Monitor Out connector

If your TV does not have an HDMI connector, or if your TV does have an HDMI connector but you are connecting some source devices with only composite video connectors, use a composite video cable (not included) to connect the AVR's Composite Monitor Out connector to your TV's composite video connector.

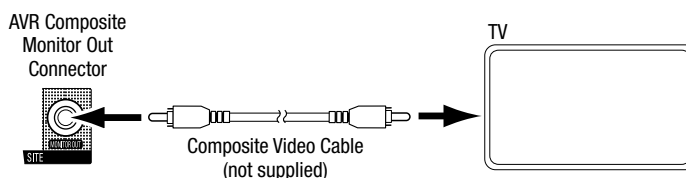

Connect Your Audio and Video Source Devices

Source devices are components where a playback signal originates, e.g. a Blu-ray Disc or DVD player; a cable, satellite or HDTV tuner; etc. Your AVR has several different types of input connectors for your audio and video source devices: HDMI, composite video, optical digital audio, coaxial digital audio and analog audio.

Your AVR's various Source Selector buttons have default assignments to different input connectors (listed in the "Default AVR Input Connector" column of the table below). For ease of setup and remote control programming, you should connect each source device to the connector where the corresponding default source button is assigned (e.g., connect your Cable/Satellite tuner box to HDMI 1).

However, you can connect your source devices as you wish and re-assign any of the video and audio input connectors to any of the Source Selector buttons listed in the table according to where you actually connect each of your source devices.

As you connect your various source components, fill out the "Connected Device" and "Assigned AVR Input Connector(s)" columns in the table – it will make it easier for you to assign the connectors to the Source Selector buttons after you have completed making all of the connections. (You will make any changes to the connector assignments later in the setup process.)

Source Selector Button	Default AVR Input Connector	Connected Device	Assigned AVR Input Connector(s)	
			Video	Audio
Cable/Sat	HDMI 1			
TV	HDMI ARC			
Disc	HDMI 2			
Server	HDMI 3			
Aux	COMP. VID. 1/AUX AUDIO			
Game	HDMI 5			
STB	HDMI 6			
Audio	ANALOG AUDIO 2			
Network	NETWORK	Home Network	—	—

Input Connections and Source Buttons

HDMI devices

If any of your source devices have HDMI connectors, using those connectors will provide the best possible video and audio performance quality. Since the HDMI cable carries both digital video and digital audio signals, you do not have to make any additional audio connections for devices you connect via HDMI cables.

If you have a TV or other source device equipped with the HDMI Audio Return Channel function, you can feed its sound to the AVR via the HDMI Monitor Out connector's Audio Return Channel, and it will not require additional audio connections to the AVR.

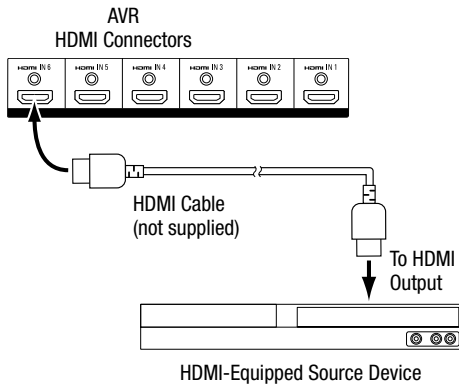

Composite video devices

Use composite video connectors for video source devices that don't have HDMI connectors. You will also need to make an audio connection from the source device to the AVR.

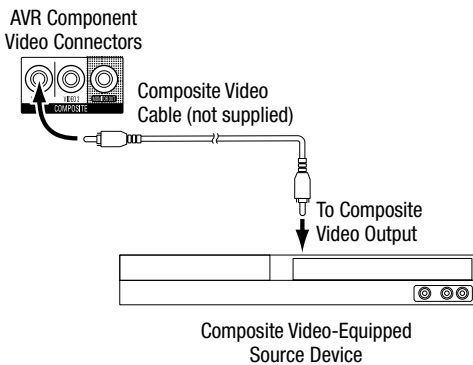

Optical digital audio devices

If your non-HDMI source devices have optical digital outputs, connect them to the AVR's Optical Digital Audio connectors. **NOTE: Make only one type of digital connection (HDMI, optical or coaxial) from each device.**

NOTE: Be sure to remove the caps from the tips of the optical cable before inserting them into the AVR and your source device.

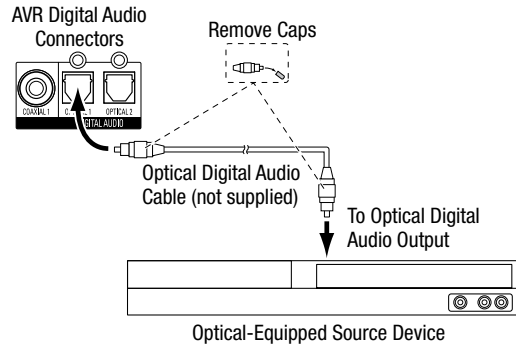

Coaxial digital audio devices

If your non-HDMI source devices have coaxial digital outputs, connect them to the AVR's Coaxial Digital Audio connectors.

NOTE: Make only one type of digital connection (HDMI, optical or coaxial) from each device.

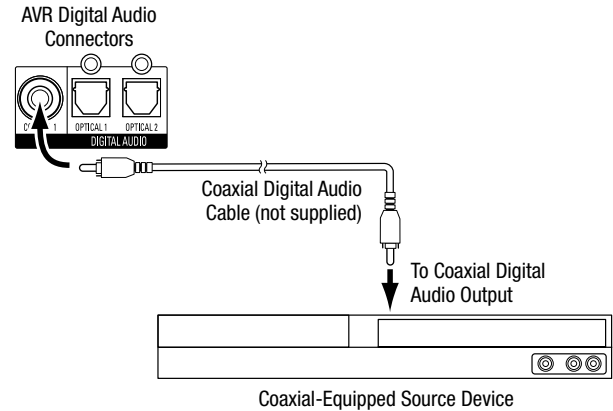

Analog audio devices

Make analog audio connections from your source devices that do not have HDMI or digital audio connectors.

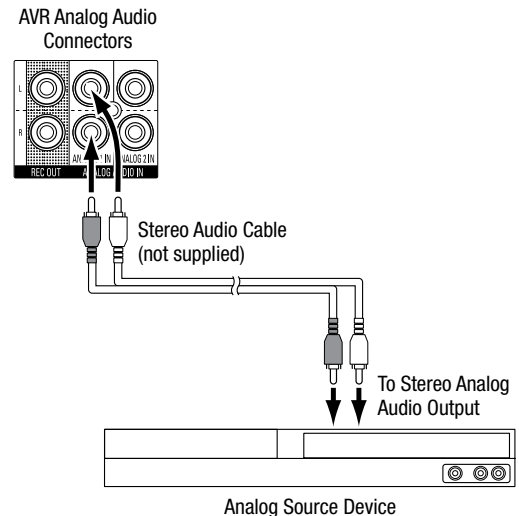

Audio recorders

Connect an analog audio recorder's inputs to the AVR's analog audio Rec Out connectors. The recorded signal is determined by the source's Record Out setting in the Source Setup menu. See *Additional Source Setup Menu Items*, on page 19, for more information.

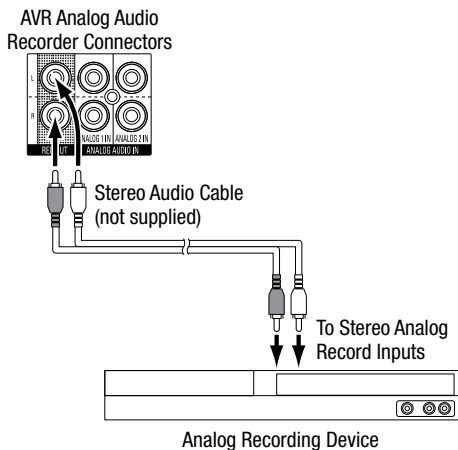

Video recorders

Connect an analog video recorder's video input connector to the AVR's Composite Monitor Out connector. You can record any composite video signal. To record the audio and video from the source device, connect the AVR's Analog Rec Out connectors to the analog video recorder's audio inputs.

NOTE: If you have connected the AVR's Composite Monitor Out video connector to your TV, you cannot connect a VCR to the AVR for recording.

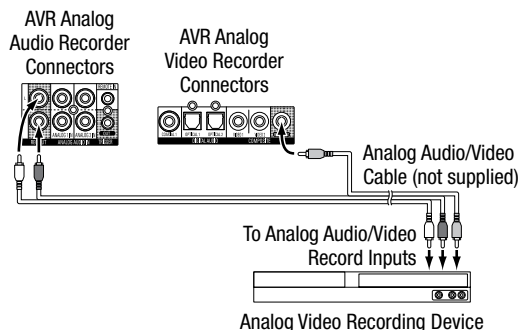

Connect to Your Home Network

Use a Cat. 5 or Cat. 5E cable (not supplied) to connect the AVR's Network connector to your home network to enjoy Internet radio and content from DLNA®-compatible devices that are connected to the network.

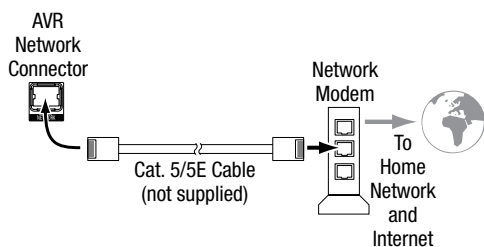

Connect the Radio Antennas

- Connect the supplied FM antenna to the AVR's FM 75Ω Radio Antenna connector. For the best reception, extend the FM antenna as far as possible.
- Bend and fold the base of the supplied AM antenna as shown and connect the antenna wires to the AVR's AM and Gnd connectors. Rotate the antenna as necessary to minimize background noise.

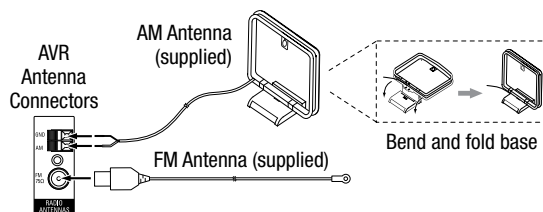

Connect IR Equipment

If you place the AVR inside a cabinet or facing away from the listener so that the AVR's IR sensor is not within line-of-sight of the remote control, connect an external IR receiver, such as the Harman Kardon HE 1000 (available separately) to the AVR's IR In connector.

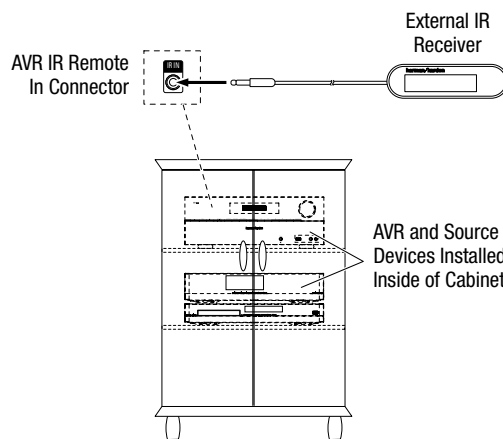

Connect the Trigger Output

If your system has equipment that can be controlled by a DC trigger signal, connect it to the AVR's Trigger Out connector with a mono 1/8-inch (3.5mm) mini-plug interconnect cable. The AVR will supply a 12V DC (100mA) trigger signal at this connection whenever it is powered on.

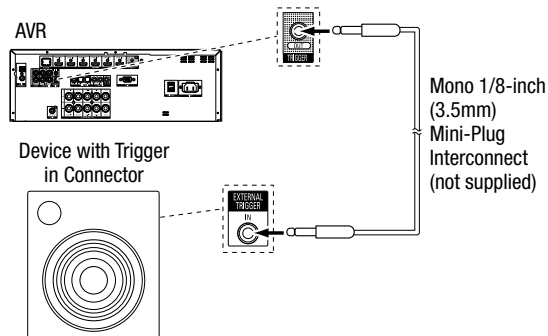

Connect to AC Power

Connect the AC power cord to the AVR's AC Input connector and then to a working AC power outlet.

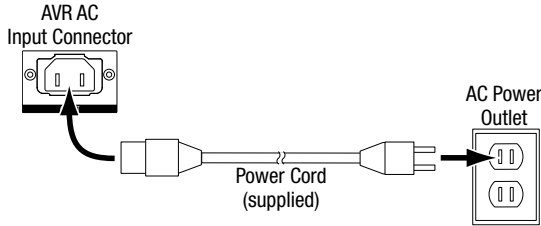

Set Up the Remote Control

Install the Batteries in the Remote Control

Remove the remote control's battery cover, insert the three supplied AAA batteries as shown in the illustration, and replace the battery cover.

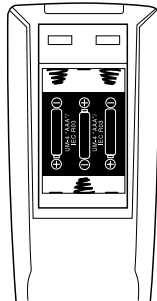

NOTE: Remove the protective film from the AVR's front panel to keep it from reducing the remote control's effectiveness.

Program the Remote to Control Your Source Devices and TV

In addition to using the remote to control the AVR itself and the AM/FM radio, you can program the remote to control up to five additional audio/video source devices plus your TV via the Cable/Sat, Disc, Server, Game, STB and TV Source Selector buttons. The remote is also ready to operate your iPod or iPhone device when the device is connected to the AVR's front-panel USB port.

Once you have programmed the remote, you can switch the remote's control mode to access the functions for a particular source device by pressing the remote's Source Selector button for that device. To control the AVR, press the remote's AVR button.

Before you begin programming the remote, review the connections you filled in on the Input Connections and Source Buttons table on page 13. The Source Selector buttons are assigned to the components that you listed in the table's "Connected Device" column.

Each of the programmable Source Selector buttons is set at the factory to control that specific type of device: the Cable/Sat button is set to control cable/satellite tuners, the Disc button is set to control DVD and Blu-ray Disc players, the Server button is set to control digital music servers, the Game button is set to control game consoles, the STB box is set to control DVRs and TiVo® devices, and the TV button is set to control TVs.

You can program an unused Source Selector button to control a source device that is different from that button's factory setting (such as programming the Server button to control a DVD player or a second TV), but completely different types of devices, such as CD players and VCRs, cannot be controlled at all. See *Advanced Remote Control Programming*, on page 26, for more information.

1. Turn on the source device you want to program the remote to control.
2. Look up the code numbers for the device in Tables A10 – A17 in the Appendix. Write all the applicable code numbers in a convenient place.
3. Press and hold the Source Selector button for that source device until the Program Indicator LED on the remote starts to flash, then release it. (This procedure places the remote in the Programming mode.)
4. Aim the remote at the source device and use the remote's Number buttons to enter a code number from Step 2, above.
 - a) If the device turns off, press the Source Selector button again to save its code. The Source Selector button will flash, and the remote will exit the Programming mode.
 - b) If the device does not turn off, enter another code number.
 - c) If you run out of code numbers for a device, you can search through all of the codes in the remote's library for devices of its type by pressing the Up or Down button repeatedly until the device turns off. When it does, press the Source Selector button to save the code.
5. Check that other functions control the device correctly. Sometimes manufacturers use the same Power code for several models, while other function codes vary. Repeat this process until you've programmed a satisfactory code set that operates most of the device's functions.
6. If you searched through the remote's code library to find the code, you can find out which code number you have programmed by pressing and holding the Source Selector button to re-enter the Programming Mode. Then press the remote's OK button, and the Program Indicator LED will flash in the code sequence. One flash represents "1," two flashes represent "2," and so forth. A series of quick flashes represents "0." Record the code number programmed for each device in Table A6 in the Appendix.

Repeat Steps 3 – 6 for each source device you want to control with the AVR remote.

In general, the label for each button on the remote describes the button's function when used to control the AVR. However, the button may perform a very different function when used to control another device. Refer to the *Remote Control Function List*, Table A9 in the Appendix, for each button's functions with the various product types.

You can also program the remote to perform macros (preprogrammed code sequences that execute many code commands with a single button press) and "punch-through" programming (allowing the remote to operate a device's channel or transport controls when the remote is in another device's mode). See *Advanced Remote Control Programming*, on page 26, for instructions on these functions.

Set Up the AVR

Turn On the AVR

1. Set the rear-panel Main Power switch to "On." (The front-panel Power indicator will glow amber.)
2. Press the front-panel Power button.

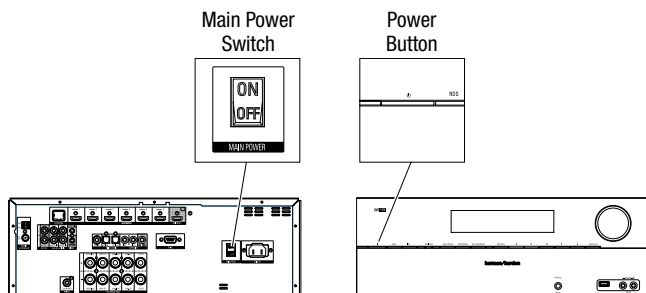

Unless you will not be using the AVR for an extended period of time, leave the Main Power switch set to "On." When the Main Power switch is turned off, any settings you have programmed will be preserved for up to four weeks.

IMPORTANT NOTE: If the PROTECT message ever appears in the Message display, turn off the AVR and unplug it. Check all speaker wires for a short circuit ("+" and "-" wires touching). If none is found, bring the unit to an authorized Harman Kardon service center for inspection and repair before using it again.

Using the On-Screen Menu System

Although it's possible to configure the AVR using only the remote and the front-panel Message display, it is easier to use the on-screen menu system.

To access the menus, press the OSD button on the remote. The Master Menu will appear. (Note: If you have only used a composite video connection to your TV, the OSD menus will not appear on your TV. Follow the steps below using the receiver's front-panel display.)

NOTE: The OSD screens shown in this manual may differ slightly from the actual screens.

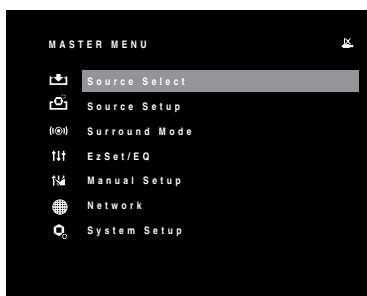

The Master menu consists of seven submenus: Source Select, Source Setup, Surround Mode, EzSet/EQ, Manual Setup, Network and System Setup.

Use the Up/Down/Left/Right buttons on the remote to navigate the menu system, and press the OK button to select a menu or setting line, or to enter a new setting.

The current menu, setting line or setting will appear in the front-panel Message display, as well as on screen.

To return to the previous menu, press the remote control's Back button.

Most users should follow the instructions in this *Set Up the AVR* section to configure a basic home theater system. You may return to these menus at any time to make additional adjustments, such as those described in the *Advanced Functions* section, on pages 23 through 27.

Before you begin initial setup, all loudspeakers, a video display and all source devices should be connected to the AVR. You should be able to turn on the AVR and view the Master menu when you press the OSD button. If necessary, reread the *Making Connections* section and the beginning of this section before continuing.

Configure the AVR for Your Speakers

NOTE: If there are fewer than five main speakers in your system, do not use the EzSet/EQ process. Instead, proceed as described in *Manual Speaker Setup*, on page 24.

1. Plug the supplied EzSet/EQ microphone into the AVR's Headphone connector.

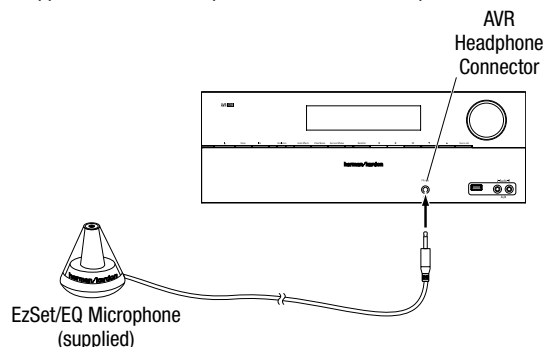

2. Place the microphone at ear height in your listening position. The microphone features a threaded insert on the bottom for mounting on a camera tripod.
3. Set the volume control on your subwoofer to approximately the halfway point.
4. Turn on your TV and select the TV input where you connected the AVR in *Connect Your TV or Video Display*, on page 13.
5. Press the remote control's OSD button. The AVR's on-screen display (OSD) Master Menu will appear on the TV.



6. Use the remote's arrow and OK buttons to select "EzSet/EQ."

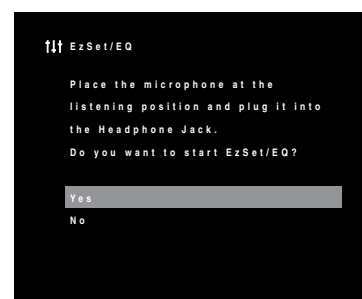

7. Select "YES." The Speaker Configuration menu will appear.



8. Select "5.1."
9. The test will begin. Make sure that the room is quiet while the test noise is playing through the speakers.
10. When the test finishes, press the remote's OSD button to exit.

Assign the AVR Input Connectors

1. Review the input connections you listed on the connection table, on page 13. Note what changes (if any) you have made from the default AVR Input Connector assignments that appear on the list. If you connected your source devices according to the entries in the "Default AVR Input Connector" column of the table on page 13, you can skip this section.
2. Turn on your TV and select the TV input where you connected the AVR in *Connect Your TV or Video Display*, on page 13.
3. Press the remote control's OSD button. The AVR's on-screen display (OSD) Master Menu will appear on the TV.

NOTE: If you have used a composite video connection to your TV, the OSD menus will not appear on your TV. Follow the steps below using the AVR's front-panel display.



4. Use the remote's arrow and OK buttons to select "Source Setup." If there is a Source Selector for which you want to assign different video or audio connections, use the left/right arrow buttons to select it, and press the OK button.



5. Select "Video In" and use the left/right arrow buttons to select the video input connector you want to assign to the Source Selector button. Press the OK button.

NOTE: If you select an HDMI connector for the Video connection the Audio connection will automatically change to the same HDMI connector.

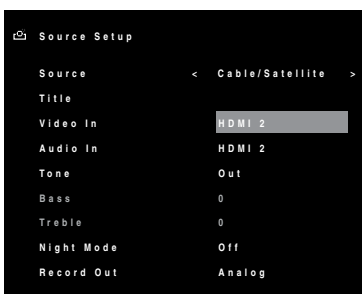

6. Select "Audio In" and use the left/right arrow buttons to select the audio input connector you want to assign to the Source button.

NOTE: If you have assigned an HDMI Video connector for the Source button you cannot assign a different Audio connector.

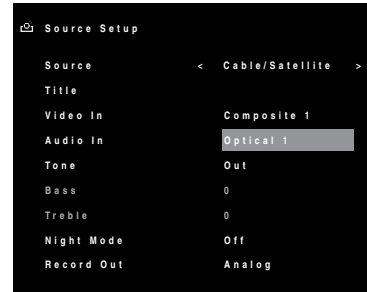

7. Repeat steps 4 – 6 for the remaining audio/video connections that you want to re-assign.

Set Up the Network

To play MP3 or WMA media located on DLNA-compatible devices connected to the network, to use the AVR's internal Internet radio tuner (vTuner) to listen to audio streams or to stream audio to the AVR via AirPlay, connect the AVR's Network connector to the Ethernet port on a router or modem that has Internet access, to a home network, or to a PC. (See *Connect to Your Home Network*, on page 15.)

We recommend that you connect the AVR directly to a home-network router so that it can directly access the Internet for Internet radio and access other devices on the network for playback of shared content (see *Listening to Media on Your Home Network*, on page 21, for more information).

If your network uses an automatic IP address, you should not have to perform any network setup procedures. Once you connect the AVR to your home network, the network should automatically assign the AVR an IP address, and the AVR should automatically connect to your network. If your AVR does not automatically connect to your network (in which case the AVR will display a "Not Connected" message when you press the Network source button):

1. Press the OSD button and select Network. The Network setup menu will appear.

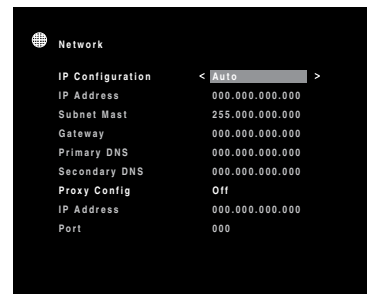

2. Select IP Configuration, then press the Left or Right button twice to cycle the setting from "Auto" to "Manual" and back to "Auto."
3. Scroll to the bottom of the list and select "Apply & Save." The AVR will enter the Standby mode. When you turn the AVR back on, it will attempt to connect to the network.
4. If the AVR again fails to connect to the network, you may need to enter your network's settings manually. In this case, you must obtain these settings from your ISP or network administrator. After obtaining your network's settings:
 - a) Select IP Address and use the Left or Right button to change the setting to "Manual." The following settings will become active: IP Address, Subnet Mask, Gateway, Primary DNS and Secondary DNS.
 - b) Use the Up/Down arrow buttons to select the correct numbers and make the entries for all of these settings.

c) When you have finished, select “Apply & Save,” and press the OK button. The AVR will refresh the network connection while it remains on. If the AVR cannot connect to the network using the manual settings, contact your ISP or network administrator for assistance.

- **Proxy Config:** If you have connected the AVR’s Network connection to a proxy network, use the Left/Right buttons to set this to “On”, and use the number buttons to enter the proxy network’s IP address and port.
- **Network Status:** This line indicates the AVR’s current network-connection status (Connected/Not Connected/Network Problem).
- **Apply & Save:** Any time you make a change in any of the Network settings, the Apply & Save line will become available. Select this line and press the OK button. The AVR will go into the Standby mode. After you turn the AVR back on, the new network settings will be in effect. **IMPORTANT: You must select “Apply & Save” for your network settings to take effect.**

NOTE: If you have trouble connecting to the network at any time, cycle the AVR into the Standby mode, and then turn it back on.

Additional Source Setup Menu Items

You can also adjust the following settings independently for each source:

Title: You may change the display name for any source (except the radio). This feature may help you to select the correct source device even when you have forgotten which physical connections you used.

1. Move the cursor to the Title line and press the OK button. A block cursor will blink.
2. Use the Up/Down buttons to scroll through the alphabet in upper and lower case, the numbers and many punctuation marks. When you have selected the desired character, press the Right button to move to the next space. Press the Right button twice to leave a blank space.
3. Press the OK button when you have finished.

Tone: This setting determines whether the treble and bass controls are active. When this line is set to Out, the tone controls are out of the circuit, with no changes to the sound. When this line is set to In, the bass and treble frequencies are boosted or cut, depending upon the Bass and Treble settings (see below).

Bass and Treble: Boost or cut the low or high frequencies by up to 10dB by using the Left/Right buttons to change the setting by 2dB at a time.

Night Mode: This setting activates Night mode with specially encoded Dolby Digital discs or broadcasts. Night mode compresses the audio so that louder passages are reduced in volume to avoid disturbing others, while dialogue remains intelligible. Each press of the right arrow button advances through the following settings:

- **Off:** No compression is applied. Loud passages in the program remain as they were recorded.
- **Mid:** Loud passages in the program are reduced moderately in volume.
- **Max:** Loud passages in the program are reduced more in volume.

Record Out: This setting determines the source of the signal that appears at the Analog Audio Rec Out connectors for the Cable/Sat, TV, Disc, Server, Aux, Game, STB and Audio sources:

- **DSP Down mix:** This setting outputs audio from digital audio input connections (HDMI, optical, coaxial) and analog audio input connections (Analog 1/2, Aux).
- **Analog:** This setting outputs audio only from the analog audio input connections (Analog 1/2, Aux).

NOTE: Although the USB, FM/AM, AirPlay, DLNA, and Internet Radio sources do not have Record Out settings, they are also available for recording.

When you’re finished, press the remote’s OSD button to turn off the on-screen menu.

Operating Your AVR

Now that you have installed your components and completed a basic configuration, you are ready to begin enjoying your home theater system.

Controlling the Volume

Adjust the volume either by turning the front-panel Volume knob (clockwise to increase volume or counterclockwise to decrease volume) or by pressing the Volume Up/Down buttons on the remote. The volume is displayed as a negative number of decibels (dB) below the 0dB reference point.

0dB is the maximum recommended volume for your AVR. Although it’s possible to turn the volume to a higher level, doing so may damage your hearing and your speakers. For certain more dynamic audio materials, even 0dB may be too high, allowing for damage to equipment. Use caution with regard to volume levels.

Muting the Sound

To mute all speakers and the headphones, press the Mute button on the remote. Any recording in progress will not be affected. The MUTE message will appear in the front-panel display as a reminder. To restore the sound, press the Mute button again, or adjust the volume.

Listening Through Headphones

Plug the 1/4-inch stereo plug on a pair of headphones into the front-panel Phones jack for private listening. The default headphone surround mode for all sources except FM and AM is HARMAN Headphone, which will emulate a 5.1-channel speaker system. The default surround mode for FM and AM is 2-Ch Stereo. Press the Surround Mode button on the front panel or use the remote and OSD to switch between HARMAN Headphone and 2-Ch Stereo. No other surround modes are available for headphone listening.

Selecting a Source

There are three different ways to select a source:

- Press the front-panel Source Select buttons.
- Directly select any source by pressing its Source Selector button on the remote.
- Select a source from the Source Select menu in the OSD menu system.

The AVR selects the audio and video inputs you assigned to the source and any other settings you made during setup.

The source name and the surround mode will appear on the front panel.

Video Troubleshooting Tips

If there is no picture:

- Check the source selection.
- Check all connections for a loose or incorrect connection.
- Check the video-input selection on the TV/display device.

Additional Tips for Troubleshooting HDMI Connections

- Turn off all devices (including the TV, the AVR and any source components).
- Unplug the HDMI cables, starting with the cable between the AVR and the TV, and continuing with the cables between the AVR and each source device.
- Carefully reconnect the cables from the source devices to the AVR. Connect the cable from the AVR to the TV last.
- Turn on the devices in this order: TV, AVR, source devices.

NOTE: Depending upon the particular components involved, the complexity of the required communication between HDMI components may cause delays of up to a minute in the completion of some actions, such as input switching or switching between SD and HD channels.

Listening to FM and AM Radio

Select the Radio source. Use the Tuning Up/Down buttons to tune a station, which will be shown on the front-panel display and the TV screen.

The AVR defaults to automatic tuning, meaning each press of the Tuning Up/Down buttons scans until a station with acceptable signal strength is found. To switch to manual tuning, in which each press of a Tuning button steps through a single frequency increment, press the Tuning Mode button. Each press of the Tuning Mode button toggles between the automatic and manual tuning modes.

Once you have tuned an FM station, toggling the Tuning Mode setting also switches the radio between stereo and monaural reception. (Mono reception may improve reception of weaker stations.)

Preset Stations

A total of 30 stations (AM and FM combined) may be stored as presets. When the desired station has been tuned in, press the Memory button on the remote, and two dashes will flash on the front-panel Message display. Use the Number buttons to enter the desired preset number.

To tune a preset station, press the Preset Up/Down buttons or enter the preset number using the Number buttons.

Listening to Internet Radio (vTuner™)

Your AVR's Network connection brings you a world of MP3- and WMA-format streams via the Internet. After you have successfully connected to your home network as described in *Connect to Your Home Network*, on page 15, and set up the network as described in *Set Up the Network*, on page 18, press the Network Source Selector button on the remote until Internet Radio appears on the AVR's front-panel display. (Each press cycles between the Network and Internet Radio sources.)

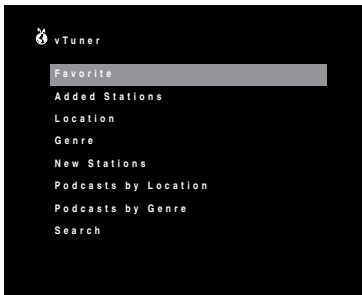

With the vTuner screen (above) displayed, the AVR will automatically connect to the Internet via the www.radioharmankardon.com portal. To select a stream, use the Up/Down buttons to select a category.

NOTE: The categories displayed may vary by region.

Once you select a stream, the OSD will display the vTuner playback screen, which contains information about the currently playing song.

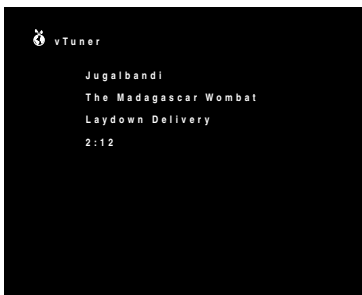

Favorites: To create a Favorites list:

- 1) Write down your AVR's MAC Address number, which is found in the Network Setup menu. See *Set Up the Network*, on page 18, for more information.
- 2) Log onto www.radioharmankardon.com from your computer. Create an account using your AVR's MAC address as its ID number.

Favorites that you select on the Web site will be available when you listen to vTuner on the AVR.

Listening to an iPod/iPhone/iPad Device

When a compatible iPod, iPhone or iPad is connected to the AVR's USB port, you may play the audio materials on the device through your high-quality audio/video system, operate the iPod, iPhone or iPad using the AVR remote, view navigation messages on the AVR's front panel or a connected video display and charge the connected device.

After connecting your iPod, iPhone or iPad to the AVR's USB port, press the USB Source Selector button. (If "USB" appears as the source, press the button a second time to switch from the USB source to the iPod source.) The iPod menu screen will appear.

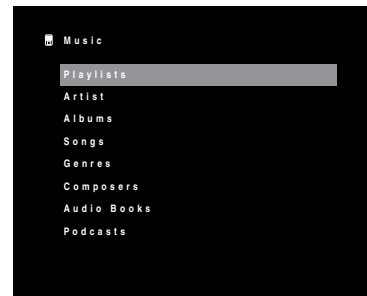

Use the Up/Down and OK buttons to navigate through the list and select the desired category. When the category's screen appears, use the Up/Down and OK buttons to navigate within the category and make selections. NOTE: Not all categories may appear with all iPod/iPhone/iPad devices.

Once you select a song the iPod playback screen will appear on the OSD.

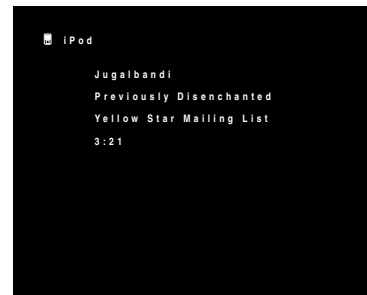

The screen will show the currently playing song, artist, album, elapsed time and total track time. Use the remote's Transport Control buttons to control playback.

- To return to a previous menu screen at any time, press the Back button.

Listening to Media on a USB Device

Your AVR is compatible with USB 2.0 or USB 1.1 media in the FAT 16 or FAT 32 file format and is compatible with the following MP3 and WMA media:

- MP3: Bit rates between 96kbps and 320kbps. Fixed bit-rates at 44.1kHz sampling is recommended. Variable bit-rates (VBR) are playable, but playing time may be displayed incorrectly. Files must have an ".mp3" file extension.
- WMA: Bit rates of 64kbps or higher.

NOTE: Bit rates of 80kbps and 256kbps are not compatible. Files must have a ".wma" file extension.

A maximum number of 65,536 folders and files can be supported.

Playing files on a USB device

1. Insert the USB drive into the AVR's front-panel USB port.

IMPORTANT: Do not connect a personal computer or peripheral to the USB port. USB hubs are not supported.

2. Select USB as the source device. (If "iPod" appears as the source, press the button a second time to switch from the iPod source to the USB source.) The USB screen will appear.

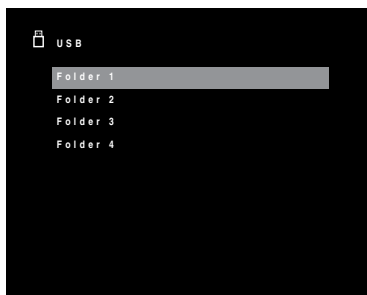

3. Use the remote's Up, Down and OK buttons to select a folder and display its contents.

4. Use the remote's Up, Down and OK buttons to select a song. The song will play and the USB playback screen will appear on the OSD.

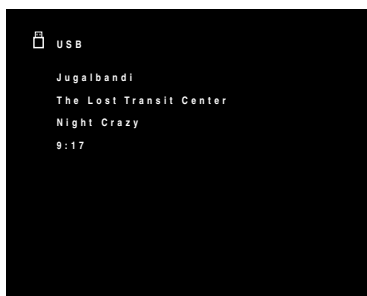

- Use the remote's Transport Control buttons to control playback.
- To access Shuffle and Repeat functions, press the remote's Options button.

When the song is finished playing the remaining contents of the folder will play.

Listening to Media via Your Home Network

Your AVR can play MP3 and WMA audio media that is stored on a PC or Mac computer when both the computer and the AVR are connected to your home network router.

MP3 compatibility: Mono or stereo, constant bit rates (CBR) from 8kbps to 320kbps, variable bit rates (VBR) from lowest to highest quality, with sample rates from 8kHz to 48kHz.

WMA compatibility: Ver. 9.2, stereo CBR with 32kHz – 48kHz sampling rate and 40kbps – 192kbps bit rate, mono CBR with 8kHz – 16kHz sampling rate and 5kbps – 16kbps bit rate, VBR Pass Encoding and Quality Encoding 10 – 98, 44kHz and 48kHz sampling rate.

NOTE:

- A PC must be running Windows Media® Player version 11 or higher, Windows Media Center version 2.0 or 3.0, or Intel® Media Server. We recommend that any firewalls be turned off, although Windows Media Player may automatically make any necessary adjustments to the firewall settings to allow media sharing.
- An Apple Macintosh computer must be running DLNA (Digital Living Network Alliance)-compliant software such as HARMAN Media Manager. To download the free HARMAN Media Manager software, go to <http://www.locale.harmanardon.com/en-US/hmm/mediamanager.html>.

IMPORTANT: Before you can access files located on other devices via the network, each device must first give permission to share files with the AVR:

To share media on PCs:

1. Open Windows Media Player.
2. Open the Library menu and select "Media Sharing." The Media Sharing window will appear.
3. Check the "Share My Media" box. An icon for the AVR will appear in the window.
4. Select the AVR icon, select "Allow," then select "OK."

The computer's WMA and MP3 media should now be available to the AVR.

To share media on other types of computers, operating systems or media software, check the instructions for the computer, operating system or media player.

To listen to shared media:

1. Press the Network Source Selector button. (If "Internet Radio" appears as the source, press the button a second time to switch from the Internet Radio source to the Network source.) The Network screen will appear.

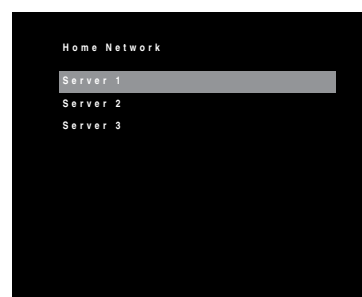

The screen should list by name all devices on the network that allow sharing.

2. Use the remote's Up, Down and OK buttons to select a device. The screen will display the device's folder structure.
3. Use the Up and Down buttons to browse the content stored in the device's media player library. Scroll to the desired item and press the OK button to select it. The song will play and the Network playback screen will appear on the OSD.

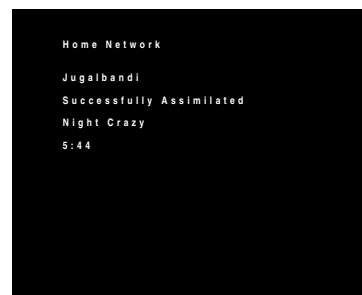

- Use the remote's Transport Control buttons to control playback.
- To access Shuffle and Repeat functions, press the remote's Options button.

When the song is finished playing the remaining contents of the folder will play.

NOTE:

- The Repeat settings are global for Network playback and USB playback. Changing these settings for one of these sources will change the other source's settings as well.
- Although video content may appear in the menu, the AVR does not support video playback from the Network connection.

Listening to Media via AirPlay

If you have connected the AVR to a network router that has Wi-Fi® capability, you can wirelessly stream audio to it via AirPlay from compatible Apple devices with iOS 4.2 or newer that are joined on the same Wi-Fi network, and from computers that have iTunes 10.1 or newer that are joined on the same Wi-Fi or wired network.

To initiate AirPlay streaming to the AVR:

- To initiate AirPlay streaming from a computer with iTunes, launch iTunes, click on the AirPlay button that appears at the bottom of the computer's iTunes window, and select "HK AVR170" in the pop-up list that appears.



- To initiate AirPlay streaming from an iPod, iPhone or iPad device, tap the AirPlay button on the device's screen and select "HK AVR 170" in the speaker-selection list that appears.

The AirPlay audio stream will break in and interrupt the source that is currently playing through the AVR. The AirPlay screen will appear on the OSD.

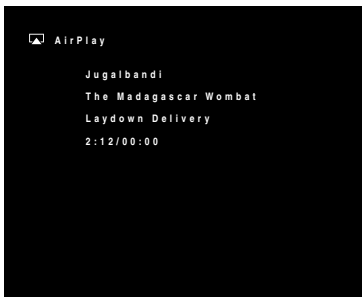

Use the remote's Transport Control buttons to control playback.

To terminate AirPlay streaming and return to the previously playing source, press the remote's Back button at any time while the AirPlay screen is displayed.

Selecting a Surround Mode

Selecting a surround mode can be as simple or sophisticated as your individual system and tastes. Feel free to experiment, and you may find a few favorites for certain sources or program types. You can find more detailed information on surround modes in *Audio Processing and Surround Sound*, page 23.

To select a surround mode, press the OSD Button on the remote to display the Master menu:

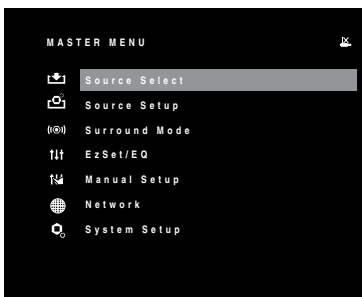

Use the Up/Down and OK buttons to select Surround Mode. The Surround Mode menu will appear:

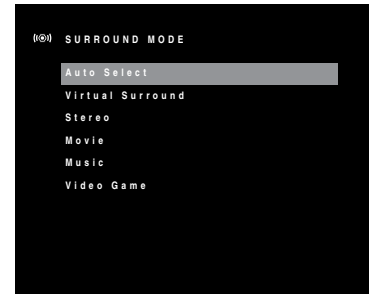

Use the Up/Down and OK buttons to select the desired surround-mode category.

Auto Select: For a digital program, such as a movie recorded with a Dolby Digital or DTS soundtrack, the AVR will automatically use the soundtrack's native surround format. For 2-channel analog and PCM programs, the AVR uses the Logic 7 Movie, Logic 7 Music or Logic 7 Game mode, depending on the source.

Virtual Surround: When only two main speakers are present in the system, you can use the Virtual Surround mode to create an enhanced sound field that virtualizes the missing speakers.

Stereo: When you want 2-channel playback, select the number of speakers you want to use for playback:

- "2 CH Stereo" uses two speakers.
- "5 CH Stereo" plays the left-channel signal through the front left and surround left speakers, the right-channel signal through the front right and surround right speakers, and a summed mono signal through the center speaker.

Movie: Select from the following when you want a surround mode for movie playback: Logic 7 Movie, DTS NEO:6 Cinema or Dolby Pro Logic II Movie.

Music: Select from the following when you want a surround mode for music playback: Logic 7 Music, DTS NEO:6 Music or Dolby Pro Logic II Music. The Dolby Pro Logic II Music mode provides some additional settings. See *Audio Processing and Surround Sound*, on page 23, for more information.

Video Game: Select from the following when you want a surround mode for game playback: Logic 7 Game or Dolby Pro Logic II Game.

After you select the Surround Mode Category, use the Left/Right buttons to change the surround mode.

You can also select surround modes using the AVR's front-panel buttons:

1. Press the Surr Mode button. The Message display will show the surround-mode category and surround mode.
2. To change the surround mode within the surround-mode category, press the Surround Select Up/Down buttons. Each press will change to the next surround mode.
3. To change the surround-mode category, press the Surr Mode button. Each press will change to the next surround-mode category.

Advanced Functions

Much of the adjusting and configuration your AVR requires is handled automatically, with little intervention required on your part. You can also customize your AVR to suit your system and your tastes. In this section, we will describe some of the more advanced adjustments available to you.

Audio Processing and Surround Sound

Audio signals can be encoded in a variety of formats that can affect not only the quality of the sound but also the number of speaker channels and the surround mode. You may also manually select a different surround mode, when available.

Analog Audio Signals

Analog audio signals usually consist of two channels – left and right. Your AVR offers several options for analog playback:

- **Stereo:** When you want conventional 2-channel playback, select “2-CH STEREO” as the surround mode. Sound will be output from the front left and right speakers (and subwoofer, if your system has one).
- **5-Ch Stereo:** When you want to hear stereo sound through all of the system’s speakers (such as during a party), select “5CH STEREO” as the surround mode. This plays the left-channel signal through the front left and surround left speakers, the right-channel signal through the front right and surround right speakers, and a summed mono signal through the center speaker (in addition to the subwoofer, if your system has one).
- **Multi-Channel Surround Modes:** Your AVR is able to process 2-channel audio signals to produce multichannel surround sound, even when no surround sound has been encoded in the recording. Among the available modes are the Dolby Pro Logic II, Virtual Surround, DTS NEO:6, and Logic 7 modes. To select one of these modes, see *Selecting a Surround Mode*, on page 22.

Digital Audio Signals

Digital audio signals offer greater flexibility and capacity than analog signals and allow the encoding of discrete channel information directly into the signal. The result is improved sound quality and startling directionality, since each channel’s information is transmitted discretely. High-resolution recordings sound extraordinarily distortion-free, especially in the high frequencies.

Surround Modes

Surround-mode selection depends upon the format of the incoming audio signal as well as your personal taste. Although there is never a time when all of the AVR’s surround modes are available, there is usually a wide variety of modes available for a given input. Table A8 in the Appendix, on page 32, offers a brief description of each mode and indicates the types of incoming signals or digital bitstreams the mode may be used with. Additional information about the Dolby and DTS modes is available on the companies’ Web sites: www.dolby.com and www.dtsonline.com.

When in doubt, check the jacket of your disc for more information on which surround modes are available. Usually, nonessential sections of the disc, such as trailers, extra materials or the disc menu, are available only in Dolby Digital 2.0 (2-channel) or PCM 2-channel mode. If the main title is playing and the display shows one of these surround modes, look for an audio or language setup section in the disc’s menu. Also, make sure your disc player’s audio output is set to the original bitstream rather than 2-channel PCM. Stop play and check the player’s output setting.

The channels included in a typical 5.1-channel recording are front left, front right, center, surround left, surround right and LFE (low-frequency effects). The LFE channel is denoted as “.1” to represent the fact that it is limited to the low frequencies.

Digital formats include Dolby Digital 2.0 (two channels only), Dolby Digital 5.1, Dolby Digital Plus (7.1), Dolby TrueHD (7.1), DTS-HD High-Resolution Audio (7.1), DTS-HD Master Audio (7.1), DTS 5.1, DTS 96/24 (5.1), 2-channel PCM modes in 32kHz, 44.1kHz, 48kHz or 96kHz, and 5.1 or 7.1 multichannel PCM. (Your AVR will downmix the discrete surround back-channel information in 6.1-channel and 7.1-channel recordings into your system’s surround left and surround right channels.)

When the AVR receives a digital bitstream, it detects the encoding method and the number of channels, which is displayed briefly as three numbers, separated by slashes (e.g., “3/2/1”).

The first number indicates the number of front channels in the signal: “1” represents a monophonic recording (usually an older program that has been digitally remastered or, more rarely, a modern program for which the director has chosen mono as a special effect). “2” indicates the presence of the left and right channels but no center channel. “3” indicates that all three front channels (left, right and center) are present.

The second number indicates whether any surround channels are present: “0” indicates that no surround information is present. “1” indicates that a matrixed surround signal is present. “2” indicates discrete surround left and right channels. (Bitstreams with discrete surround back left and right channel signals will be indicated by a “4,” although the AVR downmixes the surround back-channel information into the surround left and right channels.)

The third number is used for the LFE channel: “0” indicates no LFE channel. “.1” indicates that an LFE channel is present.

Dolby Digital 2.0 signals may include a Dolby Surround flag indicating DS-ON or DS-OFF, depending on whether the 2-channel bitstream contains only stereo information or a downmix of a multichannel program that can be decoded by the AVR’s Dolby Pro Logic decoder. By default, these signals are played in Dolby Pro Logic II Movie mode.

When a PCM signal is received, the PCM message and the sampling rate (32kHz, 44.1kHz, 48kHz or 96kHz) will appear.

When only two channels – left and right – are present, the analog surround modes may be used to decode the signal into multiple channels. If you would prefer a different surround format than the native signal’s digital encoding, press the Surround Modes button to display the Surround Modes menu (see *Selecting a Surround Mode*, on page 22).

The Auto Select option sets the surround mode to the native signal’s digital encoding, e.g., Dolby Digital, DTS, Dolby TrueHD or DTS-HD Master Audio. For analog 2-channel materials, the AVR defaults to the Logic 7 Movie mode. For Dolby Digital 2.0 programs, the AVR defaults to the Dolby Pro Logic II Movie mode, which creates a 5.1-channel surround-sound presentation from the 2-channel program. If you prefer a different surround mode, select the surround-mode category: Virtual Surround, Stereo, Movie, Music or Video Game. Press the OK button to change the mode.

Each surround-mode category is set to a default surround mode:

- Virtual: Virtual Surround.
- Stereo: 5-CH Stereo.
- Movie: Logic 7 Movie.
- Music: Logic 7 Music.
- Video Game: Logic 7 Game.

You may select a different mode for each category. Below is a complete list of available surround modes. (The actual surround modes available will depend on the number of speakers in your system.)

- Virtual: Virtual Surround.
- Stereo: 2-CH Stereo or 5-CH Stereo.
- Movie: Logic 7 Movie, Dolby Pro Logic II Movie, DTS NEO:6 Cinema.
- Music: Logic 7 Music, Dolby Pro Logic II Music, DTS NEO:6 Music.
- Video Game: Logic 7 Game, Dolby Pro Logic II Game.

Once you have programmed the surround mode for each type of audio, select the line from the Surround Modes menu to override the AVR’s automatic surround-mode selection. The AVR will use the same surround mode the next time you select that source.

Please refer to Table A8 in the Appendix for more information on which surround modes are available with different bitstreams.

Dolby Pro Logic II Music Mode Adjustments

When you select Dolby PLII as the music surround mode, additional adjustments become available:

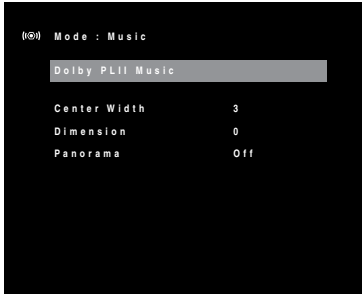

Center Width: This setting affects how vocals sound through the three front speakers. A lower number focuses the vocal information tightly on the center channel. Higher numbers (up to 7) broaden the vocal soundstage. Use the Left/Right buttons to adjust this setting.

Dimension: This setting affects the depth of the surround presentation, allowing you to “move” the sound toward the front or rear of the room. The setting of “0” is a neutral default. Setting “F-3” moves the sound toward the front of the room, while setting “R-3” moves the sound toward the rear. Use the Left/Right buttons to adjust it.

Panorama: With the Panorama mode turned on, some of the sound from the front speakers is moved to the surround speakers, creating an enveloping “wraparound” effect. Each press of the OK button toggles the setting On or Off.

Manual Speaker Setup

Your AVR is flexible and may be configured to work with most speakers and to compensate for the acoustic characteristics of your room.

The EzSet/EQ process automatically detects the capabilities of each connected speaker and optimizes the AVR’s performance with your speakers. If you are unable to run EzSet/EQ calibration, or if you wish to set up your AVR for your speakers manually, use the Manual Setup on-screen menus.

Before beginning, place your loudspeakers as explained in the *Place Your Speakers* section, on page 10, and connect them to the AVR. Consult the owner’s guide for the speakers or the manufacturer’s Web site for their frequency-range specification. Although you may set the AVR’s individual channel levels “by ear,” an SPL (sound-pressure level) meter purchased at a local electronics store will provide greater accuracy.

Record your configuration settings in Tables A3 and A5 in the Appendix for easy re-entry after a system reset or after the AVR’s Master Power switch has been turned off or the unit has been unplugged for more than four weeks.

Step One – Determine Your Speakers’ Crossover Frequencies

Without using the EzSet/EQ process, the AVR can’t detect how many speakers you’ve connected to it; nor can it determine their capabilities. Consult the technical specifications for all of your speakers and locate the frequency response, usually given as a range, e.g., 100Hz – 20kHz (±3dB). Write down the lowest frequency that each of your speakers is capable of playing (100Hz in the above example) as the crossover in Table A6 in the Appendix.

NOTE: This frequency is *not* the same as the “Crossover Frequency” that may be listed in the speaker’s specifications.

For the subwoofer, write down the transducer size. The AVR’s bass management determines which speakers will be used to play back the low-frequency (bass) portion of the source program. Sending the lowest notes to small satellite speakers will result in bad sound and may even damage the speakers. The highest notes may not be heard at all through the subwoofer.

With proper bass management, the AVR divides the source signal at a crossover point. All information above that crossover point is played through your system’s speakers, and all information below the crossover point is played through the subwoofer. This way, each loudspeaker in your system will perform at its best, delivering a more powerful and enjoyable sound experience.

Step Two – Measure the Speaker Distances

Ideally, all of your speakers would be placed in a circle, with the listening position at the center. However, you may have had to place some speakers a little farther away from the listening position than others. Sounds that are supposed to arrive simultaneously from different speakers may blur, due to different arrival times.

Your AVR provides a Distance adjustment that compensates for these real-world speaker-placement differences.

Measure the distance from each speaker to the listening position, and write it down in Table A3 in the Appendix. Even if all of your speakers are the same distance from the listening position, enter your speaker distances as described in *Set the Speaker Distances*, on this page 25.

Step Three – Manual Setup Menu

Now you are ready to program the AVR. Sit in your usual listening position, and make the room as quiet as possible.

With the AVR and video display turned on, press the OSD button to display the menu system and select Manual Setup. The Manual Setup menu will appear:

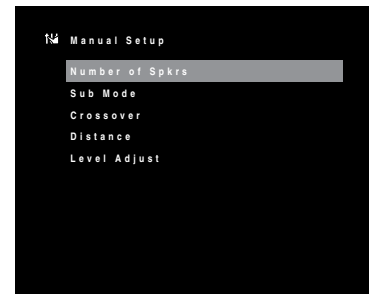

NOTE: To save your settings, press the remote’s Back button

For best results, adjust the submenus in this order: Number of Spkrs (Speakers), Crossover, Sub Mode, Distance and Level Adjust.

Number of Spkrs

This selection lets you program the correct setting for each speaker group. The settings in this menu affect the remainder of the speaker-setup process and the availability of various surround modes at any time.

Select “On” when the speakers are present in the system; select “Off” for positions where no speakers are installed. The Front Left & Right setting is always “On” and may not be disabled.

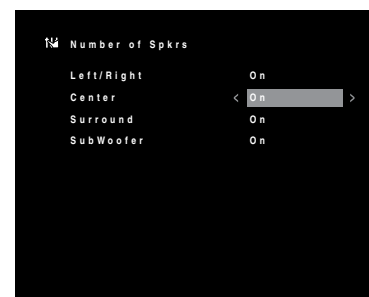

When you have finished, press the remote’s Back button.

Crossover

After you return to the Manual Setup menu, navigate to the Crossover line and press the OK button to display the Crossover menu.



Refer to Table A5 for each speaker's crossover frequency.

NOTE: The AVR will let you adjust settings only for those speaker groups you set to On in the Number of Speakers menu.

For each speaker group, select one of these eight crossover frequencies: LARGE, 40Hz, 60Hz, 80Hz, 100Hz, 120Hz, 150Hz or 200Hz. If the speaker's crossover frequency is below 40Hz, select the first option, LARGE. This setting doesn't refer to the speaker's physical size but to its frequency response, which is also called "full range."

Specify the size of the subwoofer's transducer as 8, 10, 12 or 15 inches. The AVR always sets the subwoofer crossover to 100Hz but uses the transducer size for equalization.

Write down the settings in Table A5 in the Appendix.

When you have finished entering the settings, press the remote's Back button.

Sub Mode

After you return to the Manual Setup menu, navigate to the Sub Mode line and press the OK button to display the Sub Mode menu. This setting depends upon the Crossover setting you selected for the left and right speakers.

- If you set the Left/Right speakers to a numeric crossover frequency, the subwoofer setting will always be SUB. All low-frequency information will always be sent to the subwoofer. If you don't have a subwoofer, either upgrade to full-range front left and right speakers or add a subwoofer at the earliest opportunity.
- If you set the front speakers to LARGE, select one of the three following settings for the subwoofer:

L/R+LFE: This setting sends all low-frequency information to the subwoofer, including a) low-frequency information that is also played through the front left and right speakers and b) the special low-frequency effects (LFE) channel information.

OFF: Select this setting when no subwoofer is in use. All low-frequency information will be sent to the front left and right speakers.

LFE: This setting plays low-frequency information contained in the full-range program channels through the front left and right speakers, and directs only the LFE-channel information to the subwoofer.

When you have finished entering the settings, press the remote's Back button.

Set the Speaker Distances

As described above in Step Two, when you measured the distances from each of your speakers to the listening position, your AVR provides an adjustment that compensates for the different distances so that the sound from each speaker will reach the listening position at the proper time. This process will improve the clarity and detail of the sound.

After you return to the Manual Setup menu, navigate to the Distance line and press the OK button to display the Distance menu.

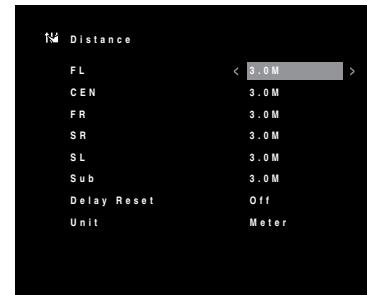

Enter the distance from each speaker to the listening position that you measured in Step Two and recorded in Table A3 in the Appendix (see page 30). Select a speaker, then use the Left/Right buttons to change the measurement. You can enter distances between 0 and 30 feet (9m). The default distance for all speakers is 10 feet (3m).

The default unit of measurement is meters. To change the unit to feet, scroll down to the Unit line and press the Left/Right buttons.

When you have finished entering the settings, press the remote's Back button.

Step Four – Setting Channel Output Levels Manually

For a conventional stereo AVR, a simple balance control adjusts the stereo imaging by varying the relative loudness of the left and right channels. In a home theater system with up to five main channels plus a subwoofer, achieving proper imaging becomes both more critical and more complex. The goal is to ensure that each channel is heard at the listening position with equal loudness (when signals of equal loudness are played through them).

Your AVR's EzSet/EQ calibration can handle this critical task for you simply and automatically. However, the AVR's Level Adjust menu allows you to calibrate the levels manually, either using the system's built-in test tone or while playing source material.

After you return to the Manual Setup menu, navigate to the Level Adjust line and press the OK button to display the Level Adjust menu.

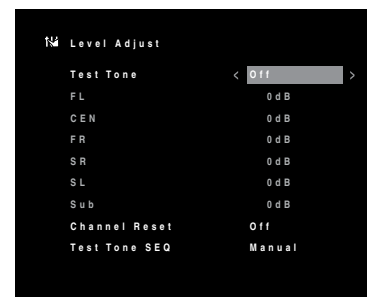

All of the system's speakers will appear with their current level settings. You can adjust each speaker's level between -10dB and +10dB in 1dB increments.

While making adjustments, you can measure the channel levels in one of these ways:

- Preferably, use a handheld SPL meter set to C-weighting, slow scale. Adjust each speaker so that the meter reads 75dB when the AVR's built-in test noise is playing.
- By ear. Adjust the levels so that the test tone sounds equally loud to you when it plays through each speaker.

To set your levels using the AVR's internal test tone, select the menu's Test Tone Seq line and use the Left/Right buttons to select between Auto and Manual. After selecting Auto or Manual, move the cursor to the Test Tone line and use the Left/Right buttons to change the setting to On.

Auto: The test tone will automatically circulate to all speakers, as indicated by the highlight bar. Use the Left/Right buttons to adjust the level for any speaker when the test tone is paused there. Use the Up/Down buttons to move the cursor to another line, and the test tone will follow the cursor. To stop the test tone, use the Up/Down buttons to move the cursor out of the screen's speaker-listings area.

Manual: The test tone will stay on the current speaker until you use the Up/Down buttons to move it to another speaker. Use the Left/Right buttons to adjust the level for the speaker through which the test tone is playing.

If you are listening to an external source while you set your output levels, set Test Tone to Off, use the Up/Down buttons to navigate to each speaker, and use the Left/Right buttons to adjust the speaker's level while the source plays.

NOTE: If you are using a handheld SPL meter with external source material, such as a test disc or an audio selection, play it and adjust the AVR's master volume control until the meter measures 75dB. Then adjust the individual speaker levels.

Channel Reset: To reset all channel levels to their factory defaults of 0dB, select this line and press the Left/Right buttons.

When you have finished adjusting the speaker levels, record the settings in Table A5 in the Appendix. Then press the remote's Back button to return to the previous menu screen, or press the remote's OSD button to exit the menu system.

Notes on Setting Speaker Volumes in Home Theater Systems:

While setting your system's individual speaker volume levels is ultimately up to your personal taste, here are some ideas you may find helpful:

- For films and video-music programs, your overall goal should be to create an enveloping, realistic sound field that draws you into the film or music program without drawing your attention away from the action on the screen.
- For multichannel music recordings, some music producers will create a sound field that places the musicians all around you; others will create a sound field that places the musicians in front of you, with more subtle ambience in the surround speakers (as you would experience in a concert hall).
- In most 5.1-channel film soundtracks, the surround speakers are not intended to be as loud or as active as the front speakers. Adjusting the surround speakers so they are always as loud as the front speakers could make dialogue difficult to understand and will make some sound effects sound unrealistically loud.

Notes on Setting Subwoofer Volume:

- Sometimes the ideal subwoofer volume setting for music is too loud for films, while the ideal setting for films is too quiet for music. When setting the subwoofer volume, listen to both music and films with strong bass content and find a "middle ground" volume level that works for both.
- If your subwoofer always seems too loud or too quiet, you may want to place it in a different location. Placing the subwoofer in a corner will always tend to increase its bass output, while placing it away from any walls or corners will always tend to lessen its bass output.

System Setup

The AVR's System Setup menu lets you customize the way many of the AVR's features operate. Press the OSD button and navigate to the System Setup line. Press the OK button to display the System Setup menu.

VFD Fade Time Out: Some people find the brightness of the AVR's front-panel display distracting during movies or listening sessions. It's possible to dim the front-panel display completely using the remote's Display Dimmer button (see *System Remote Control Functions*, on pages 8 and 9). The VFD Fade Time Out sets the display to remain dark most of the time, lighting up only when a button is pressed or a remote command is received, and going dark again five seconds after the last command. The feature also causes the display to light up only when a button is pressed but the display immediately begins to fade to dark. This setting allows you to program the length of the fade time. Select a time-out period of between three and ten seconds, or select Off if you prefer to leave the displays on at all times or to use the Display Dimmer button.

Volume Default and Default Volume Set: These two settings are used together to program the volume level the AVR defaults to when you turn it on. Set Volume Default to On, and then set the Default Volume Set to the desired turn-on volume. When Volume Default is set to Off, the AVR will turn on at the last-used volume setting from the previous listening session.

HDMI Audio To TV: This setting determines whether HDMI audio signals are passed through the HDMI Monitor Out connector to the video display. In normal operation, leave this setting at Off, as audio will be played through the AVR. To use the TV by itself, without the home theater system, turn this setting to On. In this case, you will need to mute the TV's speakers (or switch the setting to Off) when using the AVR for audio.

Semi OSD Time Out: Program the amount of time (2 to 5 seconds) the two-line semi-OSD status messages remain on screen, or deactivate the semi-OSD display altogether if you find it distracting. These messages will continue to appear on the AVR's front-panel display.

Full OSD Time Out: Program the amount of time (20, 30, 40 or 50 seconds) the full OSD menus remain visible on screen. The full OSD system may not be deactivated.

HDMI Link: This setting allows the communication of control information among the HDMI devices in your system. Turn this setting to On to allow control communication among the HDMI devices; turn the setting to Off to forbid control communication.

Adjust Lip Sync: This setting lets you resynchronize the audio and video signals from a source to eliminate a "lip sync" problem. Lip sync issues can occur when the video portion of a signal undergoes additional processing in either the source device or the video display. Use the Left/Right buttons to delay the audio by up to 180ms.

Upgrade Software: If a software upgrade is released for your AVR, installation instructions will be available in the Product Support section of the Web site or from Harman Kardon customer service. At that time, access this submenu to install the software upgrade.

IMPORTANT: During a system upgrade, do not power off the AVR or use any of its controls. Doing so could permanently damage the AVR.

Advanced Remote Control Programming

Programming an Unused Source Selector Button to Control a Different Device

You can program unused Source Selector buttons to control devices that are different than they are set up for at the factory. For example, you can program the Server button to control a second TV set.

1. Locate the code numbers for the device you want to control from the tables in Appendices 10 – 18, on pages 37 – 46.
2. Turn on the device you want to control.
3. Press the unused Source Selector button that you want to program for three seconds. The button's LED will turn on and Program Indicator LED will flash.
4. Press the Source Selector button that corresponds to the type of device you want to control. (For example, if you want to control a TV, press the TV Source Selector button.) The unused Source Selector button's LED will flash once.
5. Aim the remote toward the device you want to control and use the Number buttons to enter first code number. The Program Indicator LED will flash. If you have selected the correct code number the device will turn off. If it does not turn off, enter the next code number from the table. When the device turns off, proceed to step 6.
6. Press the unused Source Selector button from Step 3. That Source Selector button's LED will turn off and the Program Indicator LED will flash green three times.

The remote will now control the device when the formerly unused Source Selector button is pressed.

Remote Channel-Control Punch-Through

The punch-through feature allows you to operate one component while setting certain groups of controls to operate another component. For example, while using the AVR controls for surround modes and other audio functions, you may also use the remote to operate the transport controls of your Blu-ray Disc player. Or while using the remote to control video functions on your TV, you may also use the remote to change channels on your cable box.

To program punch-through control while operating any device:

1. For three seconds, press and hold the Source Selector button (or the AVR button) for the main device the remote will be operating. The Program Indicator LED will flash, indicating that the remote is in Program mode and that you may release the button.
2. Select the type of punch-through programming.
 - a) To program volume-control punch-through, press the Volume Up button.
 - b) To program channel-control punch-through, press the Volume Down button.
 - c) To program transport-control punch-through, press the Play transport-control button.
3. Press the Source Selector button for the device whose volume, channel or transport-controls you will use while operating the device selected in the first step. The Program Indicator LED will flash to confirm.

To undo punch-through programming, follow the same steps as above, but press the same Source Selector button in Steps 1 and 3.

Programming Macro Commands

Each of the AVR remote's four Macro buttons and the Power On button (see *System Remote Control Functions*, on pages 8 and 9) can be programmed to send out up to 19 commands at one time from a single button push. Any AVR remote control button's function from any mode (except the Mute button, the Dim button and the Channel Up/Down buttons) can be programmed into a macro.

NOTE: Use caution when programming complicated macros. It isn't possible to program a pause or delay before sending additional commands after a "Power On" command, and the component may not be ready to respond to commands immediately after powering on.

To program a macro:

1. Simultaneously press one of the four Macro buttons, or the Power On button, and the Mute button to enter the Programming mode.
2. Press in up to 19 commands that you want stored in that Macro button. Press the Source Selector button for each device (or AVR button for the AVR itself) before you enter individual commands. This step counts as one of the 19 commands allowed for each Macro.
3. For the Power On command, DO NOT press the Power On button. Press the Mute button instead.
4. Press the Power Off button to program the Power Off command.
5. Press the CH+ button to end the programming process and save the macro.

It isn't possible to "edit" a command within a macro. However, you may erase the macro as follows:

1. Simultaneously press and hold the Mute button and the Macro button containing the macro until the Program Indicator LED flashes.
2. Press the Channel Down button to erase the macro.

To execute a macro, press the Macro button (or the Power On button) into which you programmed the macro. Aim the remote at the AVR and the other components until all of the macro commands have been executed.

Recording

Depending on the Record Out settings you made for each source in the Source Setup menu (see *System Setup*, on page 26, for more information), analog or digital audio signals, as well as composite video signals, are normally available at the appropriate recording output connectors. To make a recording, connect your audio or video recorder to the appropriate AVR output connectors as described in the *Making Connections* section, on page 13, insert blank media in the recorder and make sure the recorder is turned on and recording while the source is playing. Refer to the recording device's instructions for complete information about making recordings.

NOTE: Please make certain that you are aware of any copyright restrictions on any material you record. Unauthorized duplication of copyrighted materials is prohibited by law.

Sleep Timer

The sleep timer sets the AVR to play for up to 90 minutes and then turn off automatically.

Press the Sleep button on the remote, and the time until turn-off will be displayed on the front-panel Message display and on a connected TV. Each additional press of the Sleep button decreases the play time by 10 minutes, with a maximum of 90 minutes. The SLEEP OFF setting disables the sleep timer.

When the sleep timer has been set, the front-panel display will automatically dim to half brightness.

If you press the Sleep button after the timer has been set, the remaining play time will be displayed. Press the Sleep button again to change the play time.

Resetting the Remote

To reset the remote to its factory-default condition, simultaneously press and hold any Source Selector button and the "0" Number button. When the Program Indicator LED flashes amber, enter the code "333." When the green LED goes out, the remote control will be reset.

Processor Reset

If the AVR behaves erratically after a power surge, first turn off the rear-panel Main Power switch and unplug the AC power cord for at least 3 minutes. Plug the cord back in and turn the AVR on. If this procedure doesn't help, reset the AVR's processor as described below.

NOTE: A processor reset erases all user configurations, including video resolution, speaker and level settings, and tuner presets. After a reset, reenter all of these settings from your notes in the Appendix worksheets.

To reset the AVR's processor:

1. Press the front-panel Standby/On switch to place the unit in the Standby mode (the Power Indicator LED will turn amber).
2. Press and hold the front-panel Surround Mode button for at least 5 seconds until the RESET message appears on the front-panel Message display.

If the AVR does not function correctly after a processor reset, contact an authorized Harman Kardon service center for assistance. Authorized service centers may be located by visiting our Web site at www.harmankardon.com.

Memory

If the AVR is unplugged or experiences a power outage, it will retain your user settings for up to four weeks.

Troubleshooting

Symptom	Cause	Solution
Unit does not function when Main Power switch is turned on	<ul style="list-style-type: none"> No AC power 	<ul style="list-style-type: none"> Ensure that the power cord is plugged into a live AC power outlet Check if the AC outlet is switch-controlled
Front-panel Message display lights, but there's no sound or picture	<ul style="list-style-type: none"> Intermittent input connection Mute is on Volume control is turned down 	<ul style="list-style-type: none"> Secure all input and speaker connections Press Mute button Turn up Volume control
No sound from any speaker; PROTECT message appears on Message display	<ul style="list-style-type: none"> Amplifier is in protection mode due to possible short circuit Amplifier is in protection mode due to internal problems 	<ul style="list-style-type: none"> Check all speaker wires at speaker and AVR connections for crossed wires Contact your local Harman Kardon service center
No sound from center or surround speakers	<ul style="list-style-type: none"> Incorrect surround mode Program material is monophonic Incorrect speaker configuration Program material is stereo 	<ul style="list-style-type: none"> Select a surround mode other than stereo Mono programs contain no surround information Check the speaker configuration in the setup menu The surround decoder may not create center- or surround-channel information from nonencoded stereo programs
Unit does not respond to remote control commands	<ul style="list-style-type: none"> Weak batteries in remote AVR not selected Remote sensor is obscured 	<ul style="list-style-type: none"> Change batteries in remote Press the Setup/AVR button Ensure that the AVR's front-panel remote sensor is in the line of sight of the remote
Intermittent buzzing in tuner	<ul style="list-style-type: none"> Local interference 	<ul style="list-style-type: none"> Move the AVR or antenna away from computers, fluorescent lights, motors or other electrical appliances
Unable to activate remote control Programming mode	<ul style="list-style-type: none"> Source Selector button is not held for at least 3 seconds 	<ul style="list-style-type: none"> Be sure to hold the Source Selector button for at least 3 seconds

Additional information on troubleshooting possible problems with your AVR and installation-related issues may be found in the list of "Frequently Asked Questions," which is located in the Product Support section of our Web site: www.harmankardon.com

Specifications

Audio Section

Stereo power:	100W per channel, two channels driven @6/8 ohms, 1kHz, <1.0% THD
Multichannel power:	100 watts per channel two channels driven @ 6/8 ohms, 1 kHz, <1.0% THD
Input sensitivity/impedance:	250mV/27k ohms
Signal-to-noise ratio (IHF-A):	100dB
Surround system adjacent-channel separation:	Dolby Pro Logic/PLII: 40dB Dolby Digital: 55dB DTS: 55dB
Frequency response:	10Hz – 100kHz
High instantaneous-current capability (HCC):	±34 amps
Transient intermodulation distortion (TIM):	Unmeasurable

FM Tuner Section

Frequency range:	87.5 – 108.0MHz
Usable sensitivity IHF:	1.3µV/13.2dBf
Signal-to-noise ratio (mono/stereo):	70dB/68dB
Distortion (mono/stereo):	0.2%/0.3%
Stereo separation:	40dB @ 1kHz
Selectivity (±400kHz):	70dB
Image rejection:	80dB
IF rejection:	80dB

AM Tuner Section

Frequency range:	520kHz – 1710kHz (AVR 1700) 522kHz – 1620kHz (AVR 170/AVR 170/230C)
Signal-to-noise ratio:	38dB
Usable sensitivity (loop):	500µV
Distortion (1kHz, 50% mod):	1.0%
Selectivity (±10kHz):	30dB

Video Section

Television format:	NTSC (AVR 1700); PAL (AVR 170/AVR 170/230C)
Input level/impedance:	1Vp-p/75 ohms
Output level/impedance:	1Vp-p/75 ohms
Video frequency response (composite video):	10Hz – 8MHz (–3dB)
HDMI:	with 3D and 12-bit Deep Color

General Specifications

Power requirement:	120V AC/60Hz (AVR 1700); 220V – 240V AC/50Hz (AVR 170/AVR 170/230C)
Power consumption (maximum):	260W (AVR 1700) 240W (AVR 170/ AVR 170/230C) <0.5W/Eco Standby mode
Dimensions (W x H x D):	17-5/16" x 6-1/2" x 14-13/16" (440mm x 165mm x 377mm)
Weight	12.8 lb (5.8kg)

Appendix – Default settings, worksheets, remote product codes

Table A1 – Recommended Source Component Connections

Device Type	AVR Source	Default Audio Connection	Default Video Connection
Cable TV, Satellite, HDTV or other device that delivers television programs	Cable/Sat	• HDMI 1 Input	• HDMI 1 Input
DVD player, Blu-ray Disc player	Disc	• HDMI 2 Input	• HDMI 2 Input
HDMI-capable music server	Server	• HDMI 3 Input	• HDMI 3 Input
HDMI-capable game console	Game	• HDMI 5 Input	• HDMI 5 Input
HDMI-capable DVR or set-top box	STB	• HDMI 6 Input	• HDMI 6 Input
Analog audio device	Audio	• Analog Audio 2	• Not required
Home network	Network	• Network	• Not required
iPod or iPhone	USB	• USB port	• Not required
Auxiliary source device	Aux	• Front-Panel Aux Input	• Component Video 1 Input

Note: Table A1 is a guideline; you may need to make adjustments to fit your system.

Table A2 – Speaker/Channel Setting Defaults

Speaker	Default Setting	Your Setting
Left/Right Speaker	ON	
Center Speaker	ON	
Surround Speaker	ON	
Subwoofer	ON	
Left/Right Speaker Crossover	100Hz	
Center Speaker Crossover	100Hz	
Surround Speaker Crossover	100Hz	
LFE	PRESENT	
Sub Mode	SUB	

Table A3 – Distance Settings

Speaker Positions	Your Distances from Speaker to Listening Position
Front Left	
Center	
Front Right	
Surround Right	
Surround Left	
Subwoofer	
A/V Sync Delay	0mS

Table A4 – Source Settings

Source	Cable/Sat	TV	Disc	Server	Aux	Game	STB	Audio	Radio	USB	Network
Title											
Video Input		N/A							N/A		N/A
Audio Input		HDMI Audio Return Channel							Internal Tuner		Network Connector
Record Out									N/A	N/A	N/A

Table A5 – Speaker/Channel Settings

	Front Left	Front Right	Center	Surround Left	Surround Right	Subwoofer
Number of Speakers	ON					
Crossover						
Distance						
Channel Level Adjust						

Table A6 – Remote Control Codes

Source Selector	Connected Device	Remote Control Code
Cable/Sat		
TV		
Disc		
Server		
Aux		
Game		
STB		
Audio		

Table A7 – System Settings

Feature	Default Setting	Your Setting
VFD Fade Time-Out	OFF	
Volume Default	OFF	
Default Vol Set	-25dB	
HDMI Audio to TV	OFF	
Semi-OSD Time-Out	5 Seconds	
Full-OSD Time-Out	20 Seconds	
HDMI Link	OFF	
HDMI ARC	OFF	

Table A8 – Surround Modes

Surround Mode	Description	Incoming Bitstream or Signal
Dolby Digital	Provides up to five separate main audio channels and a dedicated low-frequency effects (LFE) channel.	<ul style="list-style-type: none"> • Dolby Digital 1/0/.0 or .1, 2/0/.0 or .1, 3/0/.0 or .1, 2/1/.0 or .1, 2/2/.0 or .1, 3/2/.0 or .1 • Dolby Digital EX (played as 5.1) • Dolby Digital Plus decoded and delivered via coaxial or optical connection
Dolby Digital Plus	An enhanced version of Dolby Digital encoded more efficiently, Dolby Digital Plus has the capacity for additional discrete channels and for streaming audio from the Internet, all with enhanced audio quality. Source material may be delivered via an HDMI connection or decoded to Dolby Digital or PCM and transmitted via coaxial or optical digital audio.	<ul style="list-style-type: none"> • Dolby Digital Plus via HDMI connection (source device decodes to Dolby Digital when a coaxial or optical connection is used)
Dolby TrueHD	Dolby TrueHD is an expansion of MLP Lossless™ audio, the same format used on DVD-Audio discs. Dolby TrueHD adds the features found in Dolby Digital, such as night mode settings, while delivering fully lossless audio that is a true reproduction of studio master recordings.	<ul style="list-style-type: none"> • Blu-ray Disc or HD-DVD encoded with Dolby TrueHD, delivered via HDMI
Dolby Digital Stereo	Delivers a 2-channel downmix of Dolby Digital materials.	<ul style="list-style-type: none"> • Dolby Digital 1/0/.0 or .1, 2/0/.0 or .1, 3/0/.0 or .1, 2/1/.0 or .1, 2/2/.0 or .1, 3/2/.0 or .1 • Dolby Digital EX
Dolby Pro Logic II Mode Group	Analog decoder that derives five full-range, discrete main audio channels from matrix surround-encoded or 2-channel analog sources. Four variants are available.	See below
Dolby Pro Logic II Movie	Variant of Dolby Pro Logic II that is optimized for movie and television programs.	<ul style="list-style-type: none"> • Dolby Digital 2.0 or 2.1 • Analog (two-channel) • Tuner • PCM (32kHz, 44.1kHz, 48kHz, 96kHz)
Dolby Pro Logic II Music	Variant of Dolby Pro Logic II that is optimized for music selections. Allows adjustment of sound-field presentation in three dimensions: <ul style="list-style-type: none"> • Center Width (adjusts width of vocal soundstage) • Dimension (adjusts depth of soundstage) • Panorama (adjusts wraparound surround effect) 	<ul style="list-style-type: none"> • Dolby Digital 2.0 or 2.1 • Analog (two-channel) • Tuner • PCM (32kHz, 44.1kHz, 48kHz, 96kHz)
Dolby Pro Logic II Game	Variant of Dolby Pro Logic II that emphasizes use of the surround channels and subwoofer for total immersion in the video gaming experience.	<ul style="list-style-type: none"> • Dolby Digital 2.0 or 2.1 • Analog (two-channel) • Tuner • PCM (32kHz, 44.1kHz, 48kHz, 96kHz)
Dolby Pro Logic	Original version of Dolby Pro Logic that steered a mono signal containing information below 7kHz to the surround channels.	<ul style="list-style-type: none"> • Dolby Digital 2.0 or 2.1 • Analog (two-channel) • Tuner • PCM (32kHz, 44.1kHz, 48kHz, 96kHz)
Virtual Speaker	Simulates 5.1 channels when only two speakers are present or a more enveloping sound field is desired.	<ul style="list-style-type: none"> • Dolby Digital • Analog (two-channel) • Tuner • PCM (32kHz, 44.1kHz or 48kHz)
DTS Digital	Using a different encoding/decoding method from Dolby Digital, DTS Digital also provides up to five discrete main channels, plus an LFE channel.	<ul style="list-style-type: none"> • DTS 1/0/.0 or .1, 2/0/.0 or .1, 3/0/.0 or .1, 3/1/.0 or .1, 2/2/.0 or .1, 3/2/.0 or .1 • DTS-ES Matrix (played as 5.1) • DTS-ES Discrete (played as 5.1)

Table A8 – Surround Modes (cont.)

Surround Mode	Description	Incoming Bitstream or Signal
DTS-HD	DTS-HD is a high-definition audio format that complements the high-definition video found on Blu-ray Disc and HD-DVD discs. It is transmitted using a DTS core with high-resolution extensions. Even when only DTS 5.1 surround sound is desired (or available, if the multizone system is in use), the higher capacity of high-resolution discs serves up DTS at twice the bit rate used on DVD-Video discs.	<ul style="list-style-type: none"> • Blu-ray Disc or HD-DVD discs encoded with DTS-HD modes, delivered via HDMI connection
DTS-HD Master Audio	DTS-HD Master Audio technology delivers bit-for-bit reproductions of studio master recordings for an incredibly accurate performance.	<ul style="list-style-type: none"> • Blu-ray Disc or HD-DVD discs encoded with DTS-HD Master Audio technology, delivered via HDMI connection
DTS Stereo	Delivers a 2-channel downmix of DTS Digital materials or presents a matrix-encoded surround presentation.	<ul style="list-style-type: none"> • DTS 1/0/.0 or .1, 2/0/.0 or .1, 3/0/.0 or .1, 3/1/.0 or .1, 2/2/.0 or .1, 3/2/.0 or .1 • DTS 96/24 • DTS-ES Matrix
DTS Neo:6 Cinema	Delivers an enhanced 5.1-channel surround-sound experience for movies	<ul style="list-style-type: none"> • Analog (two-channel) • AM/FM radio • PCM (32kHz, 44.1kHz, 48kHz, 96kHz)
DTS Neo:6 Music	Delivers an enhanced 5.1-channel surround-sound experience for music	<ul style="list-style-type: none"> • Analog (two-channel) • AM/FM radio • PCM (32kHz, 44.1kHz, 48kHz, 96kHz)
Logic 7 Mode Group	A HARMAN proprietary technology, Logic 7 enhances two-channel and matrix-encoded recordings by deriving separate information for the surround back channels. It provides more accurate placement of sound, improves panning and expands the sound field, even when used with 5.1-channel systems. Logic 7 technology uses 96kHz processing and is available in 5.1 mode. Three variants are available.	See below
Logic 7 Movie	Especially suited to two-channel sources containing Dolby Surround or matrix encoding, Logic 7 Movie mode increases center-channel intelligibility.	<ul style="list-style-type: none"> • Analog (two-channel) • Tuner • PCM (32kHz, 44.1kHz, 48kHz, 96kHz)
Logic 7 Music	The AVR is programmed at the factory to default to this mode for two-channel signals. Logic 7 Music mode is well suited to conventional two-channel music recordings.	<ul style="list-style-type: none"> • Analog (two-channel) • Tuner • PCM (32kHz, 44.1kHz, 48kHz, 96kHz)
Logic 7 Game	Use Logic 7 Game mode to enhance enjoyment of video-game consoles.	<ul style="list-style-type: none"> • Analog (two-channel) • Tuner • PCM (32kHz, 44.1kHz, 48kHz, 96kHz)
5-Channel Stereo	Useful for parties, the left- and right-channel information is played through both the front and surround speakers on each side, while the center speaker plays a summed mono mix.	<ul style="list-style-type: none"> • Analog (two-channel) • Tuner • PCM (32kHz, 44.1kHz, 48kHz, 96kHz)
2-Channel Stereo	Turns off all surround processing and plays a pure 2-channel signal or a downmix of a multichannel signal. The signal is digitized and bass management settings are applied, making it appropriate when a subwoofer is used.	<ul style="list-style-type: none"> • Analog (two-channel; DSP downmix available for multichannel) • Tuner • PCM (32kHz, 44.1kHz, 48kHz, 96kHz)

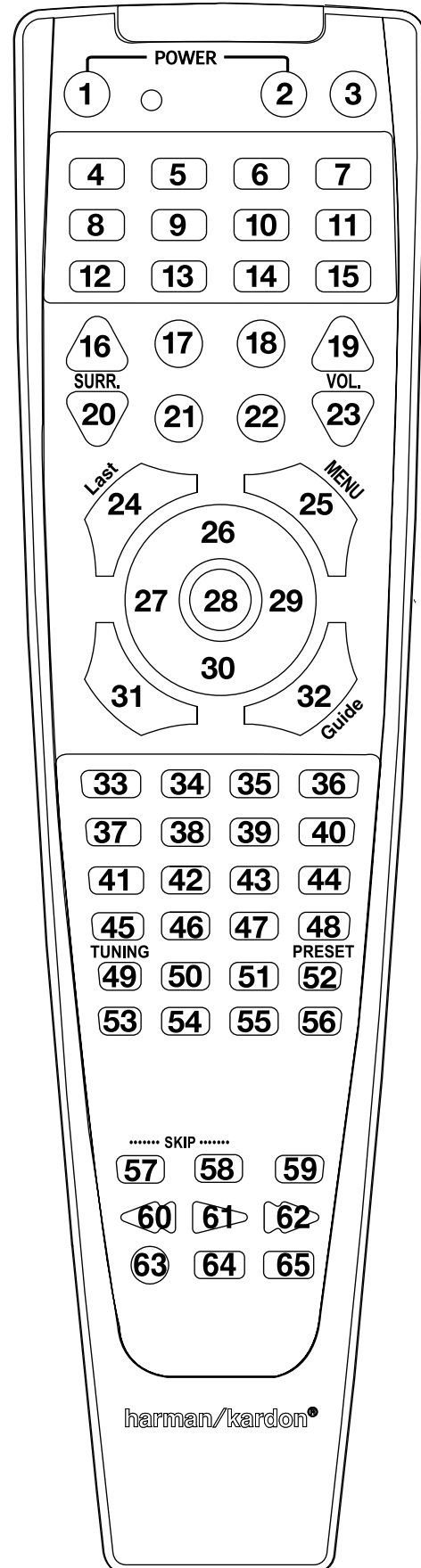

Refer to the numbered buttons when using the Remote Control Function List

Table A9 – Remote Control Function List

No.	Button Name	AVR Function	DVD	Blu-ray Disc Player	Game	TV	TiVo/DVR	DMC Music Server	Cable Tuner	Satellite Tuner	iPod/USB
01	Power On	Power On	Power On	Power On		Power On	Power On/Off	Power On	Power On	Power On	Power On
02	Power Off	Power Off	Power Off	Power Off		Power Off	TV Power	Power Off	Power Off	Power Off	Power Off
03	Mute	Mute	Mute	Mute	Mute	Mute	Mute	Mute	Mute	Mute	Mute
04	AVR	AVR Select	AVR Select	AVR Select	AVR Select	AVR Select	AVR Select	AVR Select	AVR Select	AVR Select	AVR Select
05	Cable/Sat	Cable/Sat Select	Cable/Sat Select	Cable/Sat Select	Cable/Sat Select	Cable/Sat Select	Cable/Sat Select	Cable/Sat Select	Cable Select	Sat Select	Cable/Sat Select
06	TV	TV Select	TV Select	TV Select	TV Select	TV Select	TV Select	TV Select	TV Select	TV Select	TV Select
07	Disc	Disc Select	Disc Select	Disc Select	TV Select	Disc Select	Disc Select	Disc Select	Disc Select	Disc Select	Disc Select
08	Server	Server Select	Server Select	Server Select	Server Select	Server Select	Server Select	Server Select	Server Select	Server Select	Server Select
09	Aux	Aux Select	Aux Select	Aux Select	Aux Select	Aux Select	Aux Select	Aux Select	Aux Select	Aux Select	Aux Select
10	Game	Game Select	Game Select	Game Select	Game Select	Game Select	Game Select	Game Select	Game Select	Game Select	Game Select
11	STB	STB Select	STB Select	STB Select	STB Select	STB Select	STB Select	STB Select	STB Select	STB Select	STB Select
12	Audio	Audio Select	Audio Select	Audio Select	Audio Select	Audio Select	Audio Select	Audio Select	Audio Select	Audio Select	Audio Select
13	Radio	Radio Select	Radio Select	Radio Select	Radio Select	Radio Select	Radio Select	Radio Select	Radio Select	Radio Select	Radio Select
14	USB	USB Select	USB Select	USB Select	USB Select	USB Select	USB Select	USB Select	USB Select	USB Select	USB Select
15	Network	Network Select	Network Select	Network Select	Network Select	Network Select	Network Select	Network Select	Network Select	Network Select	Network Select
16	CH+		Audio			Channel +	Channel +	Audio	Channel +	Channel +	Channel +
17	Test Tone	Test Tone		Find				Find			
18	CH.	Channel	Audio or Playlist	Audio				Status			
19	Vol Up	Volume Up	Volume Up	Volume Up	Volume Up	Volume Up	Volume Up	Volume Up	Volume Up	Volume Up	Volume Up
20	CH-		Disc Menu or Title	Disc Menu or Top Menu	Scan Down	Channel -	Channel -	Title	Channel -	Channel -	Channel -
21	Tone	Tone Controls		PIP Audio or PopUp Menu				V-Off			Tone Controls
22	Delay	Delay Adjust	Repeat	Repeat							Delay Adjust
23	Vol Down	Volume Down	Volume Down	Volume Down	Volume Down	Volume Down	Volume Down	Volume Down	Volume Down	Volume Down	Volume Down
24	Back/Last	Back	Return or Status	Return or Exit	Enter	Previous Channel	Prev CH or Instant Replay	Return or Back	Previous Channel	Previous Channel	Back
25	Options/Menu	Options	Menu or Setup	Options or Popup/Title Menu	Start	Menu	Menu	Setup	Menu	Menu	Options
26	Up	Move/Adjust Up	Up	Up	Up	Up	Up	Up	Up	Up	Up
27	Left	Move/Adjust Left	Left	Left	Left	Left	Left	Left	Left	Left	Left
28	OK	OK	Enter	Enter	Select	Enter	Select	Enter	Enter	Enter	Enter
29	Right	Move/Adjust Right	Right	Right	Right	Right	Right	Right	Right	Right	Right
30	Down	Move/Adjust Down	Down	Down	Down	Down	Down	Down	Down	Down	Down
31	OSD	OSD	HD Mode/SUB On/Off	Home/Subtitle		OSD		Info	OSD	OSD	
32	Sleep/Guide	Sleep	Disc Menu/Title	Status/Display	DVD menu			Disc Menu	Info	Info	Sleep
33	1	1	1	1	1	1	1	1	1	1	1
34	2	2	2	2	2	2	2	2	2	2	2
35	3	3	3	3	3	3	3	3	3	3	3

Table A9 – Remote Control Function List (cont.)

No.	Button Name	AVR Function	DVD	Blu-ray Disc Player	Game	TV	TiVo/DVR	DMC Music Server	Cable Tuner	Satellite Tuner	iPod/USB
36	4	4	4	4	4	4	4	4	4	4	4
37	5	5	5	5	5	5	5	5	5	5	5
38	6	6	6	6	6	6	6	6	6	6	6
39	7	7	7	7	7	7	7	7	7	7	7
40	8	8	8	8	8	8	8	8	8	8	8
41	Direct	Direct Tuner Entry	Chapter+ or Zoom								
42	9	9	9	9	9	9	9	9	9	9	9
43	0	0	0	0	0	0	0	0	0	0	0
44	Clear	Clear	Clear	Clear	Clear		Exit	Clear			Clear
45	Tuning Up	Tuning Up	Next Chapter	Program (Red)	●	Cancel		Mark/Window	PPV	Cancel	
46	Memory	Direct Tuner Entry	Angle	Bookmark (Green)	■		Repeat/Live TV	Angle	FAV	FAV	
47	TUN-M	Tuning Mode		Thumbnail (Yellow)	▲		Jump Up/Slow	A-B	Bypass	Next	
48	Preset Up	Preset Tune Up	Slow Forward	Zoom (Blue)	X		Jump Down/Skip	Source/Menu	Music	Alt	
49	Tuning Down	Tuning Down	Prev Chapter	Setup/Settings		Sleep					
50	Night	Night Mode	Subtitle	Find/Subtitle	Subtitle			Subtitle			
51	D. Skip (AVR 1700); RDS (AVR 170)	Disc Skip (AVR 1700); RDS Mode (AVR 170)	Disc Skip	Angle				Play Mode			
52	Preset Down	Preset Tune Down	Slow Rev	A-B				Zoom			
53	M1	Macro 1	Macro 1	Macro 1	Macro 1	Macro 1	Macro 1	Macro 1	Macro 1	Macro 1	Macro 1
54	M2	Macro 2	Macro 2	Macro 2	Macro 2	Macro 2	Macro 2	Macro 2	Macro 2	Macro 2	Macro 2
55	M3	Macro 3	Macro 3	Macro 3	Macro 3	Macro 3	Macro 3	Macro 3	Macro 3	Macro 3	Macro 3
56	M4	Macro 4	Macro 4	Macro 4	Macro 4	Macro 4	Macro 4	Macro 4	Macro 4	Macro 4	Macro 4
57	Skip Down	Skip –	Step –	Skip –		Scan –	Thumbs Down	Skip –	Skip – (DVD)	Skip – (DVD)	Skip –
58	Skip Up	Skip +	Step +	Skip +		Scan +	Thumbs Up	Skip +	Skip + (DVD)	Skip + (DVD)	Skip +
59	Dim	Dimmer	Dimmer					Dimmer			
60	Rewind ◀◀	R. Search	R. Search	R. Search	Rewind	Rewind	R. Search	R. Search	R. Search	R. Search	R. Search
61	Play ▶	Play	Play	Play	R. Play/F. Play	Play	Play	Play	Play (DVD)	Play (DVD)	Play
62	FF ▶▶	F. Search	F. Search	F. Search	Fast Fwd	Fast Fwd	F. Search	F. Search	F. Search	F. Search	F. Search
63	Record		Open/Close	Open/Close	Record/Pause	Record	Record	Record	Record	Record	Record
64	Stop	Stop	Stop	Stop	Stop	Stop	Stop	Stop	Stop	Stop	Stop
65	Pause	Pause	Pause	Pause	Pause	Pause	Pause	Pause	Pause	Pause	Pause

Table A10 – Remote Control Product Codes: TV

TV Manufacturer/Brand	Setup Code Number
A MARK	132 122
ACER	143 167
ADMIRAL	192 105 088 023
ADVENT	151
AIWA	027 110
AKAI	053 093 089 056 042 022 020 011
AKAL	160 123
AKURA	020
ALBA	040 020
AMPRO	164
ANAM	122 112 109 106 045
ANSONIC	049 144 145 146 147 148
AOC	128 123 122 037 146 150
APEX	154
ARC EN CIEL	059 056 024 019 017
ARCAM	017
ARISTONA	086 060 048 047 033 025 023 022
ASA	201 096 088 023 012
AUDIOVOX	012 155
AUTOVOX	088 044 025
BANG & OLUFSEN	088
BARCO	202
BASICLINE	020
BAUR	102 077 076 075
BEKO	022
BENQ	166 170 165
BLAUPUNKT	084 077 076 075 011
BLU:SENS	174 178 185 098 109 112 120 138 170 171 175
BLUE SKY	144 148 149 150 151 152 153 154 155 156 157 158
BRANDT ELECTRONIQUE	059 056 024 019 017
BRION VEGA	203 088 023
BROCKSONIC	206 205 072

TV Manufacturer/Brand	Setup Code Number
BRUNS	088 023
BUSH	092 043 040 020 010
BUSH (UK)	044
CANDLE	128 123
CAPEHART	059
CELLO	178 182
CENTURION	171 123
CENTURY	088 023
CETRONIC	045
CGE	105
CIHAN	032
CITIZEN	132 128 123 045
CLASSIC	045
COBY	104
COMTEL	032
CONCERTO	128
CONTEC	045 010
CONTINENTAL EDISON	059 056 024 019 017
CORANDO	172
CORONADO	132
CRAIG	159 158 157 045
CROSLEY	088 023
CROWN	132 045
CURTIS MATHES	128 123 132 080 082
CXC	045
DAEWOO	132 128 127 119 116 114 111 108 106 105 102 087 045 022
DANSAI	022
DAYTRON	132 128
DECCA	091 022
DECCA (UK)	038
DEGRAAF	015
DELL	075
DGM	190

Table A10 – Remote Control Product Codes: TV (cont.)

TV Manufacturer/Brand	Setup Code Number
DIBOSS	186
DIGIFUSION	184
DIGI LINK	200
DIGITREX	192
DISH NETWORK	188
DIXI	022
DORIC	029
DUMONT	201 199 096 088 023
DUMONT-FINLUX	044 012
DYNASTY	045
DYNATECH	063
DYNATRON	022 020
DYNEX	014 083 107 189
ELBE	211 105 095
DYNATRON	022 020
DYNEX	014 083 107 189
ELBE	211 105 095
ELCIT	032 023
ELECTROGRAPH	064
ELECTROHOME	132 115
ELEMENT	048 113
EMERSON	205 162 159 158 157 139 132 128 123 045 126 195 096 088 023
EMOTION	189
EPSON	074
ERRES	033 022
FENNER	022
FERGUSON	197 196 099 077 076 075 062 047 024 001
FIDELITY	047
FIDELITY (UK)	099
FINHER	204
FINLANDIA	018
FINLUX	201 199 096 088 044 012

TV Manufacturer/Brand	Setup Code Number
FIRST LINE	157 159 160 161 163 164 166 168 169
FISHER	088 043 023
FORGESTONE	099 047
FORMENTI	088
FORMENTI-PHOENIX	088
FUNAI	045 195
FUJITSU	041 042 249 250 195
FUTURETECH	045
GATEWAY	198 199
GBC	043
GE	163 159 145 133 128 123 121 087 029
GEC (UK)	061
GOODMANS	043 022 010 036 041
GORENJE	124 034
GRANADA	104 033 029 022 018 010
GRANADA (UK)	043
GRUNDIG	193 203 200 096 077 076 075 011
GVA	131
HAIER	135 213 028
HALL MARK	128
HANNSPREE	185
HANSEATIC	043 022 020 010
HARMAN KARDON	201
HIFIVOX	080 059 056 024 019 017
HINARI	195 043 020 010
HISENSE	137 140 216
HITACHI	147 144 132 128 123 206 101 094 093 085 082 080 066 061 059 058 056 055 043 035 026 024 018 015 012 010
HP	076 218
HUMAX	217 030
HYPER	206
HYPERION	073

Table A10 – Remote Control Product Codes: TV (cont.)

TV Manufacturer/Brand	Setup Code Number
HYTEK	016
HYUNDAI	220 236
IKASU	212
ILO	009 056
IMPERIAL	105
INFINITY	148
INKEL	120
INNO HIT	068
INSIGNIA	099 107
INTERFUNK	104 088 056 033 024 023 022 020
INTERVISION	121 119 118 117 116 115 114 113 111
ISIS	186
ITT	100 092 046 040
ITT-NOKIA	100 092 058 040
JBL	148
JCPENNY	145 132 128 123 115
JENSEN	019
JET POINT	208
JOHN LEWIS	193
JVC	134 087 079 092 056 053 047 043 010
KARCHER	068 012
KATHREIN	124 034
KAWASHO	173
KEC	045
KENMARK	183
KENNEDY	025
KENWOOD	204 123
KLEGG	066
KLH	006
KMC	132
KNEISSEL	105
KNOLL SYSTEMS	224

TV Manufacturer/Brand	Setup Code Number
KOGAN	180
KONKA	225
KORTING	088 023
KRIESLER	060 048 047 033 025 023 022
KTV	162 132 123 045
LEVEL	191
LG (GOLDSTAR)	132 128 122 110 101 002 013 086 022 073
LINSAR	187
LLOYTRON	173 172
LODGENET	069
LOEWE	227 027
LOEWE OPTA	088 023 022 020
LOGIK	069 099 091 047 038
LUMA	022
LUXMAN	128
LUXOR	058
LXI	148 145 077
M ELECTRONIC	201
MADNADYNE	088 023
MAGNASONIC	015
MAGNAVOX	148 145 132 128 123 030 040 088 138
MANESTH	022
MARANTZ	148 123 115 022
MARELLI	088
MARK	022
MARKS & SPENCER	182
MATSUI	148 091 043 040 038 020 001
MAXENT	199
MEDION	031
MEMOREX	128 069
METZ	084 088 077 076 075 023 011
MGA	128 123 115

Table A10 – Remote Control Product Codes: TV (cont.)

TV Manufacturer/Brand	Setup Code Number							
MINERVA	084	200	096	077	076	075	011	
MINTEK	065							
MISAKI	195							
MITSUBISHI	168	167	160	128	123	115	077	124
	092	091	090	089	083	082	079	076
	075	057	050	046	043	039	038	034
	029	023	022	020	013	011	010	007
MTC	176 175							
MURPHY	021							
NATIONAL	182	181	180	179	177	148	018	
NEC	125	123	121	115	010	043		
NECKERMANN	102	088	078	023				
NEON	182							
NIKEI	045							
NOBLEX	204	205						
NOKIA	100	092	046	040				
NORDMENDE	094	093	080	069	059	056	053	024
	019	017	009					
OKI	045	049	081	087	097			
OLEVIA	007							
ONKING	045							
ONWA	045							
OPTOMA	229							
OPTONICA	077							
ORION	211	210	209	208	207	230	091	040
	038							
OTTO VERSAND	207	102	092	078	077	076	075	043
	022	020	010					
PANASONIC	169	148	087	061	137	136	135	134
	133	132	131	130	129	128	002	004
PATHE' MARCONI	059	056	024	019	017			
PHILCO	148	132	128	123	115	045	105	088
	023							
	148	145	132	128	123	036	035	034
	033	089	108	107	104	100	099	095
	086	084	078	071	070	068	067	061
	060	054	048	047	046	033	032	027
	025	023	022	020	014	008	176	177
	179	181	213					
PHOENIX	088							

TV Manufacturer/Brand	Setup Code Number							
PIONEER	128	123	024	069	056	024	022	020
POLAROID	003	004	005	006	043			
PORTLAND	132	128	231					
PROLINE	209	020						
PROSCAN	133							
PROTECH	022							
PROTON	165	132	128	122	059	008		
QUELLE	200	096	077	076	075	044	038	022
	020	012	011					
QUASAR	087	032						
RADIO SHACK	197	196	180	132	128	045		
RADIOLA	078	060	048	047	033	025	023	022
RADIOMARELLI	088	083	082	029	023	022		
RBM (UK)	044							
RCA	163	161	145	133	128	123	115	021
	089	188						
REALISTIC	196	167	045					
REDIFFUSION	083	082	029					
REX	198	025	022					
RFT	127	126	125	124	123	122		
RTF	023							
RUNCO	153	152	044	046				
SAA	183							
SABA	094	093	088	080	069	059	056	024
	023	019	017	009				
SALORA	058	018						
SAMPO	128	123	059					
SAMSUNG	226	145	132	128	124	022	020	226
	208	205	204	068				
SANYO	054	026	091	092	043	038	023	012
	010							
SBR	086	084	061	047	046	033	022	
SCEPTRE	232							
SCHNEIDER	196	086	078	060	048	033	025	023
	022							
SCOTT	132	128	045	195				
SEARS	145	132	128					

Table A10 – Remote Control Product Codes: TV (cont.)

TV Manufacturer/Brand	Setup Code Number
SELECO	078 199 198 195 025 022
SHARP	132 128 077 062 092 207 043 010
SHERWOOD	067
SIEMENS	084 077 076 075 015 011 010
SIGNATURE	069
SINGER	105 088 023
SINUDYNE	209 210
SOLE	068 233
SONY	212 194 136 130 117 031 028 060 093 106 102 091 065 064 062 043 038 016 010 006 172 173 174 103
SOUND WAVE	020
SOUNDESIGN	128 045
SPECTRICON	122
SSS	045
STERN	198 025 022
SUNKAI	210
SUPERSCAN	195
SUPRATECH	139 140 141 142 143
SYLVANIA	148 145 128 123 025 057 094 098 142
SYMPHONIC	184 195
TANDBERG	080 056 023
TANDY	077
TATUNG	063
TCL	234
TEAC	095 244
TECHNICS	181
TECHWOOD	128
TEKNIKA	132 128 123 115 069 045 195
TELEFUNKEN	069 059 056 024
TELERENT	069
TENSAI	022
TERA	156

TV Manufacturer/Brand	Setup Code Number
THOMSON	191 190 094 093 082 080 074 072 069 059 056 053 044 040 024 09 017 009 005 003
THORN	099 047
THORN-FERGUSON	196 197 201 103 102 099 047 024
TiVo	051 052
TMK	128
TOSHIBA	202 129 063 058 096 103 105 044 092 063 043 042 037 010 001 162
TOTEVISION	132
TRISTAR	099
TRIUMPH	199 044
TRUTECH	055
UHER	044
ULTRAVOX	088 023
UNIVERSUM	201 102 077 076 075 012
VIDEO CONCEPTS	160
VIDEOCON	188
VIDIKRON	235 253
VIDTECH	128
VIEWSONIC	011 038 047 254 255
VIORE	245 237
VISTRON	194
VISUAL INNOVATIONS	183
VITO	070
VIZIO	001 002 049 050 246
VOXSON	088 023
WARDS	148 132 128 069
WATSON	077 076 075
WEGA	088 043 010
WEGA COLOR	023
WELTBlick	022
WESTINGHOUSE	017 018 023 060 100 022
WINBOOK	071
WINTERNITZ	206

Table A10 – Remote Control Product Codes: TV (cont.)

TV Manufacturer/Brand	Setup Code Number
YAMAHA	128 123 238 239
YORK	128
YUPITERU	045
ZANUSSI	198 025 022
ZENITH	090 069 240
ZONDA	122

Table A11 – Remote Control Product Codes: DVD

DVD Manufacturer/Brand	Setup Code Number
APEX	033
APEX DIGITAL	061
ARCAM	029
BUSH	070
CALIFORNIA AUDIO	040
COBY	007 013
DENON	051 019 020
DYNEX	014
GE	004 103
HARMAN KARDON	001 002 003 032
INSIGNIA	050 046
JVC	006
KENWOOD	069
KLH	068
LG (GOLDSTAR)	066 064 055 005 010 047
LINN	031
MAGNAVOX	056 022 025
MARANTZ	059
MITSUBISHI	036 023
NAD	062
ONKYO	048 009
PANASONIC	044 035 030 024 008 042
PHILIPS	056 016

Table A11 – Remote Control Product Codes: DVD (cont.)

DVD Manufacturer/Brand	Setup Code Number
PIONEER	065 041 038 018 027
PROCEED	060
PROSCAN	004 103 037
RCA	004 103 037
SAMSUNG	054 053 017 034
SHARP	028 049
SONY	167 045 043 011 012 015 052 057
THOMSON	004 103
TOSHIBA	067 058 009 021 026
XENTA	071
YAMAHA	063 030
ZENITH	064 055 005
ZENITH DIVX	039

Table A12 – Remote Control Product Codes: SAT

SAT Manufacturer/Brand	Setup Code Number
AIWA	441
AKAI	333
ALBA	411 301
ALPHASTAR	472
ALPHASTAR DBS	450
ALPHASTAR DSR	442
AMSTRAD	432
ANKARO	421
ASTRO	483 482 481 480 479 478 477 476
BARCOM	421
BIRDVIEW	425
BLAUPUNKT	390 338
BUSH	406 348
BUSH(UK)	353
CANAL	313 378
CANAL DIGITAL	313

Table A12 – Remote Control Product Codes: SAT (cont.)

SAT Manufacturer/Brand	Setup Code Number
CANAL PLUS (CANAL+)	313
CHANNEL MASTER	361 325 321 320
CHAPARRAL	451 316 315
CITOH	360
DIRECTV	302 303 305 309 310 314
DISH NETWORK	364
DRAKE	481 413 318 317 313
DX ANTENNA	483 379 352 331
ECHOSTAR	347 321 325 328 485 484 478 477 463 453 397 395 364 308 338 340
ELECTRO HOME	392
FERGUSON	424 411 406 367 364 363 353 352 348 345
FINLUX	310 309
FOXTEL	316 376
FTE	380
FUBA	421 347 314
FUJITSU	334 329 324
GOLDEN INTERSTAR	320
GOODMANS	411
GRUNDIG	390 367 353 338 315 374
HITACHI	411 406 455 304
HOUSTON TRACKER	463
HUGHES	489 437 305 306
HUMAX	307 372
ITT	367
ITT-NOKIA	367
JANIEL	366
JERROLD	484 468 454
KATHREIN	390 380 333 301 410
KCPI	337 380
KOSMOS	380
KYOTO GMI ATLAN	443
LEGEND	453

SAT Manufacturer/Brand	Setup Code Number
LEMON	474
LOEWE	475
LORENZEN	474 465 464 463 461
MACOM	371 370 369 365 317
MAGNAVOX	473 461
MARANTZ	333
MASPRO	406 353
MEMOREX	453
METZ	390
MINERVA	390
MITSUBISHI	390 307
MOTOROLA	312 319
MULTISTAR	380
NEC	373 346 336 330
NETA P562	440
NEXTWAVE	423
NOKIA	367
NORSAT	346 373
OPTIMUS	466
OTTO VERSAND	390
PACE	424 367 364 363 353 348 317 339 487 328 343 382
PACE MSS SERIES	367
PANASONIC	424 331 469 366 457 353
PANSAT	420
PERSONAL CABLE	418
PHILIPS	424 421 353 333 332 319 375
PICO	407
PREMIERE	308 357
PRESIDENT	404 381
PRIMESTAR	475 468 454 412 302
QUADRAL	473 472 471 470 469 468 467 466
QUELLE	390

Table A12 – Remote Control Product Codes: SAT (cont.)

SAT Manufacturer/Brand	Setup Code Number
RADIOLA	353
RADIX	347
RCA	335 490 465 439 301 458 358 367
REALISTIC	480 349
SAMSUNG	432 427 380 334 442 322 326 345
SAT	427
SATELLITE SERVICE	388 335
SCIENTIFIC ATLANTA	339 356
SCHNEIDER	353
SIEMENS	390 338
SKY	306 317 318 343 344
SKY MASTER	433
SKYLAB	421
SONY	329 405 362 341
STAR CHOICE DBS	459
STARCAST	347
SUPER GUIDE	423 327
TECHNISAT	347
TEECOM	409 393 391 390 333 330
TELECOM	341
TELEFUNKEN	383
THORN-FERGUSON	367 364 348 363 353 352 345 323
TOPFIELD	311 363
TOSHIBA	470 462 461 460 426 302
UNIDEN	480 479 466 403 389 381 355 354 351 350 349 348 332 323
VIASAT	312 377
VORTEC	442 432
WISI	427 347 326 327 322 304
ZEHNDER	427 380
ZENITH	344 488 419 394 387 385 384 359

Table A13 – Remote Control Product Codes: Cable

Cable Manufacturer/Brand	Setup Code Number
ABC	011 001
ALLEGRO	111
AMERICAST	212
AMINO	015 031
ARCHER	112
BELCOR	113
BT CABLE	007
CABLE STAR	113 033
CABLETIME	016 012 011 008
CISCO	016 021 032 033
CITIZEN	111
CLYDE CABLE VISION	017
COLOUR VOICE	090 085
COMCAST	007 040 054 014 015
DESCAT CANAL	010
DIGI LINK	114
EAGLE	186
EASTERN	070 066
ELECTRICORD	039
EMERSON	112
FILMNET	020 018
FOCUS	116
FOXTEL	043 019
FRANCE TELECOM	021 013
GEC	017
G.I	097 096 017 011 001
GC ELETRONICS	113
GEMINI	060 032
GENERAL	210
GENERAL INSTRUMENT	210 054 040
GOODMIND	112
HANLIN	208 175 117 101 100 099 056

Table A13 – Remote Control Product Codes: Cable (cont.)

Cable Manufacturer/Brand	Setup Code Number
HITACHI	188 001
JASCO	111
JERROLD	210 188 162 097 096 073 017 011 002 001
LINSAY	118
MACOM	191
MAGNAVOX	068 019 017
MOTOROLA	022 023 026 031 034 035 036 038
MOVIE TIME	039 035
NSC	190 035
OAK	220 197
PACE	179
PANASONIC	214 189 177 176 053
PANTHER	114
PHILIPS	090 085 020 019 013 023
PIONEER	216 215 209 171 119 041 001 002
POPULAR MECHANIC	116
PRELUDE	120
PRIMESTAR	162
QUEST	037 041
RADIOSHACK	213 112 111
RCA	214 053
RECOTON	116
REGAL	208 101 100 099 056
REMBRANT	032
SAGEM	028
SAMSUNG	003 186 072 002 024
SATBOX	004
SCIENTIFIC ATLANTA	222 221 203 183 038 039 026 025 006 005
SEAM	121
SIGNATURE	188 001
SPRUCER	189 177 081 053
STARCOM	163 011 002

Cable Manufacturer/Brand	Setup Code Number
STARGATE	120
TANDY	024
TELECAPATION	028
TELESERVICE	011
TEXSCAN	036
TFC	122
TIMELESS	123
TiVo	029 030
TOCOM	205 170
TUDI	027
UNITED CABLE	011 001
UNIVERSAL	113 042 039 034 033
VIDEOWAY	211 124
VISIOPASS	009
VIEWSTAR	190 089 086 053 025 019
WESTMINSTER CABLE	007
ZENITH	219 211 125 065
ZENTEK	116

Table A14 – Remote Control Product Codes: Game Console

Game Console/Brand	Setup Code Number
MS (X-BOX, XBOX360)	001 003
NYKO (PS3)	005
SONY (PS2, PS3)	002 004

Table A15 – Remote Control Product Codes: Music Server

Music Server/Brand	Setup Code Number
APPLE	008 009 014
ASUS	016
BEYOND	003
ESCIENT (FIREBALL)	004 005 006 007
HARMAN KARDON	001 002

Table A15 – Remote Control Product Codes: Music Server (cont.)

Music Server/Brand	Setup Code Number
IOMEGA	022 023
LOGITECH	012
MICROSOFT	003
NAIM	011
NETGEAR	020 021
NIXEUS	024
REQUEST	010
ROKU	015
SONOS	013
SONY	017 018
WESTERN DIGITAL	019

Table A16 – Remote Control Product Codes: DVR

DVR/Brand	Setup Code Number
DAEWOO	004 001
ECHOSTAR	016 015 014
EXPRESSVU	014
HUGHES	027 017
HYUNDAI	018
KEEN	009
PANASONIC	023 010
PHILIPS	024 017 011 027
PROSCAN	019
RCA	019 027
REPLAYTV	026 025 012 010 008
SONICBLUE	012 010
SONY	024 023 022 021 020 013 007

Table A17 – Remote Control Product Codes: TiVo

TiVo/Brand	Setup Code Number
TiVo Series2™ DT DVR	302
TiVo HD DVR	304
TiVo HD XL DVR	310
TiVo Series3	309
TiVo Series4	309
PREMIERE	309
DIRECTV TiVo	306 312
PIONEER TiVo	301
TOSHIBA TiVo	303
HUMAX TiVo	303
COMCAST TiVo	311
Nero LiquidTV TiVo	303
RCN TiVo	309
SUDDENLINK TiVo	309
ONO TiVo	309
VIRGIN MEDIA TiVo	313
OTHER TiVo	305 307 308



HARMAN

HARMAN International Industries, Incorporated
8500 Balboa Boulevard, Northridge, CA 91329 USA

© 2012 HARMAN International Industries, Incorporated. All rights reserved.

Harman Kardon and Logic 7 are trademarks of HARMAN International Industries, Incorporated, registered in the United States and/or other countries. EzSet/EQ is a trademark of HARMAN International Industries, Incorporated. AirPlay, Apple, iPad, iPhone, iPod, iTunes and Mac are trademarks of Apple Inc., registered in the U.S. and other countries. Blu-ray Disc is a trademark of the Blu-ray Disc Association. DLNA is a registered trademark of the Digital Living Network Alliance. Dolby and Pro Logic are registered trademarks of Dolby Laboratories. MLP Lossless is a trademark of Dolby Laboratories. DTS is a registered trademark, and DTS 96/24, DTS-HD and DTS-HD Master Audio and DTS Neo:6 are trademarks of DTS, Inc. HDMI is a registered trademark of HDMI Licensing LLC in the United States and other countries. Intel is a registered trademark of Intel Corporation. iOS is a registered trademark of Cisco Systems, Inc., and/or its affiliates in the United States and certain other countries. TiVo is a registered trademark of TiVo Inc. Series2 is a trademark of TiVo Inc. vTuner is a trademark of Nothing Else Matters Software, Ltd., Inc. Wi-Fi is a registered trademark of the Wi-Fi Alliance. Windows Media is a registered trademark of Microsoft Corporation in the United States and/or other countries.

Features, specifications and appearance are subject to change without notice.

HKP4052 Rev: A

harman/kardon
by HARMAN

www.harmankardon.com