

AVR 1650/AVR 165

Audio/video receiver

Owner's Manual



INTRODUCTION	3	SET UP THE AVR	17
SUPPLIED ACCESSORIES	3	TURN ON THE AVR	17
IMPORTANT SAFETY INFORMATION	3	USING THE ON-SCREEN MENU SYSTEM	17
PLACE THE AVR	3	CONFIGURE THE AVR FOR YOUR SPEAKERS	17
FRONT-PANEL CONTROLS	4	ASSIGN THE DIGITAL AUDIO CONNECTORS	18
REAR-PANEL CONNECTORS	6	ADDITIONAL INPUT SETUP MENU ITEMS	18
SYSTEM REMOTE CONTROL FUNCTIONS	8	OPERATING YOUR AVR	19
INTRODUCTION TO HOME THEATER	10	CONTROLLING THE VOLUME	19
TYPICAL HOME THEATER SYSTEM	10	MUTING THE SOUND	19
MULTICHANNEL AUDIO	10	LISTENING THROUGH HEADPHONES	19
SURROUND MODES	10	SELECTING A SOURCE	19
PLACE YOUR SPEAKERS	10	LISTENING TO FM AND AM RADIO	19
PLACING THE LEFT, CENTER AND RIGHT SPEAKERS	10	LISTENING TO AN iPod/iPhone DEVICE	19
PLACING THE SURROUND SPEAKERS	10	VIDEO TROUBLESHOOTING TIPS	19
PLACING THE SUBWOOFER	10	SELECTING A SURROUND MODE	20
TYPES OF HOME THEATER SYSTEM CONNECTIONS	11	ADVANCED FUNCTIONS	20
SPEAKER CONNECTIONS	11	AUDIO PROCESSING AND SURROUND SOUND	20
SUBWOOFER CONNECTIONS	11	MANUAL SPEAKER SETUP	21
SOURCE DEVICE CONNECTIONS	11	SYSTEM SETUP	23
VIDEO CONNECTIONS	12	ADVANCED REMOTE CONTROL PROGRAMMING	24
RADIO CONNECTIONS	12	RECORDING	24
USB PORT	12	SLEEP TIMER	24
MAKING CONNECTIONS	13	RESETTING THE REMOTE	24
CONNECT YOUR SPEAKERS	13	PROCESSOR RESET	24
CONNECT YOUR SUBWOOFER	13	MEMORY	24
CONNECT YOUR TV OR VIDEO DISPLAY	13	TROUBLESHOOTING	25
CONNECT YOUR SOURCE DEVICES	13	SPECIFICATIONS	26
CONNECT THE BRIDGE IIIIP	15	APPENDIX	27
CONNECT THE RADIO ANTENNAS	15		
CONNECT IR EQUIPMENT	15		
CONNECT THE 12V TRIGGER OUTPUT	16		
CONNECT TO AC POWER	16		
SET UP THE REMOTE CONTROL	16		
INSTALL THE BATTERIES IN THE REMOTE CONTROL	16		
PROGRAM THE REMOTE TO CONTROL YOUR SOURCE DEVICES AND TV	16		

Introduction

Thank you for choosing this Harman Kardon product!

For more than fifty years, the Harman Kardon mission has been to share a passion for music and entertainment, using leading-edge technology to achieve premium performance. Sidney Harman and Bernard Kardon invented the receiver, a single component designed to simplify home entertainment without compromising performance. Over the years, Harman Kardon products have become easier to use while offering more features and sounding better than ever.

The AVR 1650 and AVR165 5.1-channel digital audio/video receivers (AVRs) continue this tradition with some of the most advanced audio and video processing capabilities yet and a wealth of listening and viewing options.

To obtain the maximum enjoyment from your new AVR, please read this manual and refer back to it as you become more familiar with its features and their operation.

If you have any questions about this product, its installation or its operation, please contact your Harman Kardon retailer or custom installer, or visit our Web site at www.harmankardon.com.

Supplied Accessories

The following accessory items are supplied with your AVR. If any of these items are missing, please contact your Harman Kardon dealer, or Harman Kardon customer service at www.harmankardon.com.

- System remote control
- EzSet/EQ™ microphone
- AM loop antenna
- FM wire antenna
- Three AAA batteries
- AC power cord

IMPORTANT SAFETY INFORMATION

Verify Line Voltage Before Use

The AVR 1650 has been designed for use with 120-volt alternating current (AC). The AVR 165 has been designed for use with 220 – 240-volt AC. Connection to a line voltage other than that for which your AVR is intended can create a safety and fire hazard, and may damage the unit. If you have any questions about the voltage requirements for your specific model or about the line voltage in your area, contact your selling dealer before plugging the unit into a wall outlet.

Do Not Use Extension Cords

To avoid safety hazards, use only the power cord supplied with your unit. We do not recommend that extension cords be used with this product. As with all electrical devices, do not run power cords under rugs or carpets, or place heavy objects on them. Damaged power cords should be replaced immediately by an authorized service center with a cord meeting factory specifications.

Handle the AC Power Cord Gently

When disconnecting the power cord from an AC outlet, always pull the plug; never pull the cord. If you do not intend to use your AVR for any considerable length of time, disconnect the plug from the AC outlet.

Do Not Open the Cabinet

There are no user-serviceable components inside this product. Opening the cabinet may present a shock hazard, and any modification to the product will void your warranty. If water or any metal object such as a paper clip, wire or staple accidentally falls inside the unit, disconnect it from the AC power source immediately, and consult an authorized service center.

CATV or Antenna Grounding (AVR 1650)

If an outside antenna or cable system is connected to this product, be certain that it is grounded so as to provide some protection against voltage surges and static charges. Section 810 of the United States National Electrical Code, ANSI/NFPA No. 70-1984, provides information with respect to proper grounding of the mast and supporting structure, grounding of the lead-in wire to an antenna discharge unit, size of grounding conductors, location of antenna discharge unit, connection to grounding electrodes and requirements of the grounding electrode.

NOTE TO CATV SYSTEM INSTALLER: This reminder is provided to call the CATV (cable TV) system installer's attention to article 820-40 of the NEC, which provides guidelines for proper grounding and, in particular, specifies that the cable ground shall be connected to the grounding system of the building, as close to the point of cable entry as possible.

Place the AVR

- Place the AVR on a firm and level surface. Be certain that the surface and any mounting hardware can support the AVR's weight.
- Provide proper space above and below the AVR for ventilation. If you install the AVR in a cabinet or other enclosed area, provide cooling air within the cabinet. Under some circumstances, a fan may be required.
- Do not obstruct the ventilation slots on the top of the AVR or place objects directly over them.
- Do not place the AVR directly on a carpeted surface.
- Do not place the AVR in moist or humid locations, in extremely hot or cold locations, in areas near heaters or heat registers, or in direct sunlight.

Front-Panel Controls

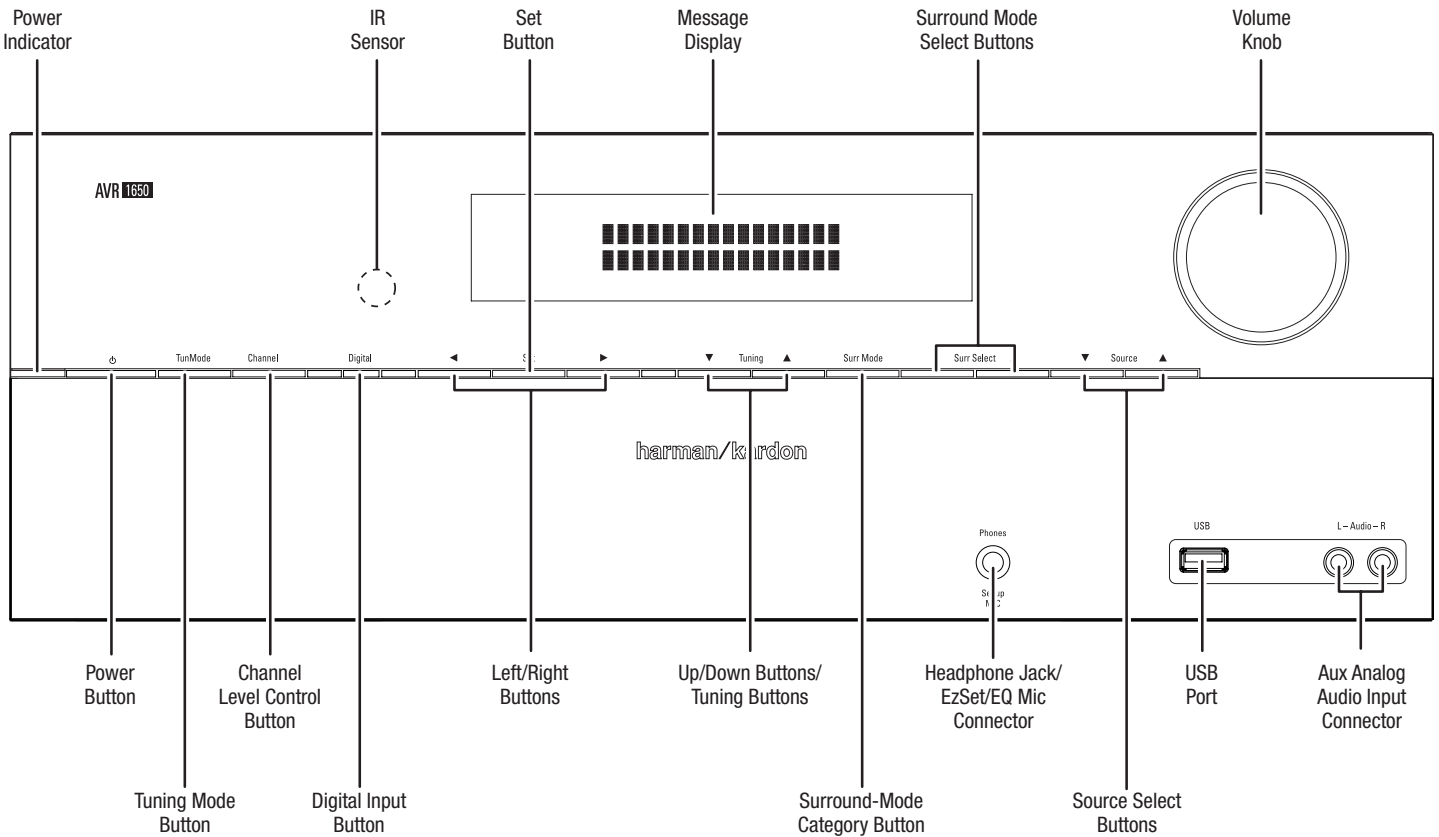

Front-Panel Controls, continued

Power indicator: This LED has three possible modes:

- LED is off: Indicates that the AVR is unplugged or the rear-panel Main Power switch is off.
- LED glows amber: Indicates that the AVR is in the Standby mode.
- LED glows white: Indicates that the AVR is turned on.

IMPORTANT NOTE: If the PROTECT message ever appears on the AVR's front-panel Message display, turn off the AVR and unplug it from the AC outlet. Check all speaker wires for a possible short circuit (the "+" and "-" conductors touching each other or both touching the same piece of metal). If a short circuit is not found, bring the unit to an authorized Harman Kardon service center for inspection and repair before using it again.

IR sensor: This sensor receives infrared (IR) commands from the remote control. It is important to ensure that the sensor is not blocked.

Set button: Press this button to select the currently highlighted menu item.

Message display: Various messages appear in this two-line display in response to commands and changes in the incoming signal. In normal operation, the current source name appears on the upper line, while the surround mode is displayed on the lower line. When the on-screen display menu system (OSD) is in use, the current menu settings appear.

Surround-Mode Select buttons: After you have selected the desired surround-mode category, press these buttons to select a specific mode within the category, such as to change from Dolby® Pro Logic® II Movie mode to Logic 7® Movie mode. Surround-mode availability depends on the nature of the source input signal, i.e., digital versus analog, and the number of channels encoded within the signal.

Volume knob: Turn this knob to raise or lower the volume.

Power button: Press this button to turn the AVR on or to place it in the Standby mode.

Tuning Mode button: This button toggles between manual (one frequency step at a time) and automatic (seeks frequencies with acceptable signal strength) tuning mode. It also toggles between stereo and mono modes when an FM station is tuned in.

Channel Level Control button: Press this button to activate the channel-level adjustment feature. After pressing this button, use the Up/Down buttons to select the channel for adjustment and use the Left/Right buttons to adjust the channel's level.

Digital Input button: Press this button to change the audio input for the current source. Use the Left/Right buttons to cycle through the available inputs. Although you can assign any digital audio input to any source, the analog audio inputs are all permanently dedicated to the source with which they are labeled.

Left/Right buttons: Use these buttons to navigate the AVR's menus.

Up/Down buttons/Tuning buttons: Use these buttons to navigate the AVR's menus. When the radio is the active source, use these buttons to tune stations according to the setting of the Tuning Mode button (see above).

Surround-Mode Category button: Press this button to select a surround-sound category. Each press changes the surround-mode category: Auto Select, Virtual, Stereo, Movie, Music and Video Game. To change the specific surround-sound mode within the category, use the Surround Mode Select buttons. See *Audio Processing and Surround Sound*, on page 20, for more information on surround modes.

Headphone jack/EzSet/EQ Mic connector: Connect a 1/4" stereo headphone plug to this jack for private listening. This jack is also used to connect the supplied microphone for the EzSet/EQ procedure described in *Configure the AVR for Your Speakers*, on page 17.

Source Select buttons: Press these buttons to select the active source.

USB port: You can use this port to perform software upgrades that may be offered in the future. Do not connect a storage device, a peripheral product or a PC here, unless instructed to do so as part of an upgrade procedure.

Aux Analog Audio Input connector: Connect an auxiliary source component that will be used only temporarily, such as a camcorder, portable music player or game console, here.

Rear-Panel Connectors

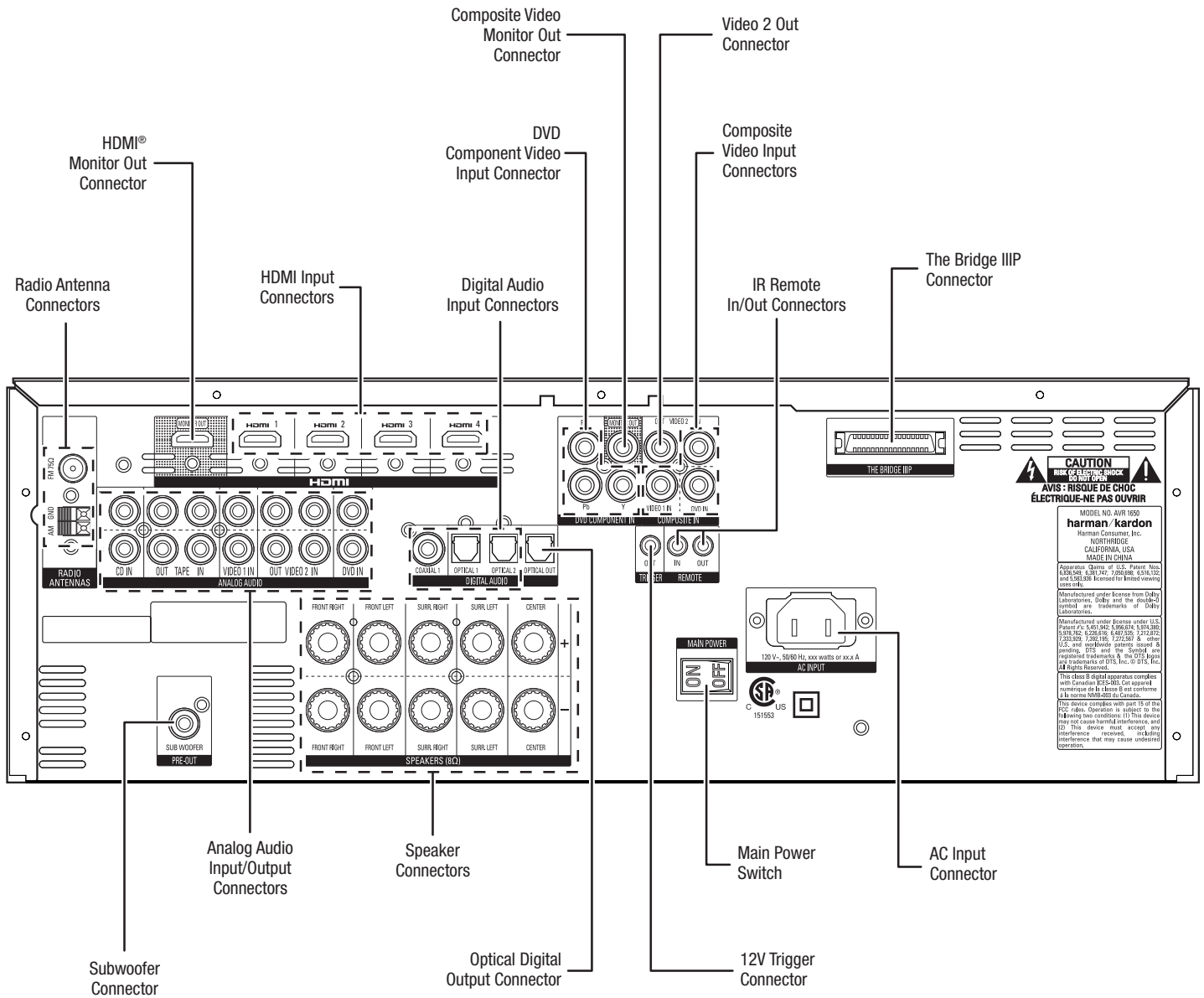

AVR 1650/AVR 165 Rear-Panel Connections (AVR 1650 shown)

Rear-Panel Connectors, continued

Radio Antenna connectors: Connect the included AM and FM antennas to their respective terminals for radio reception.

HDMI Monitor Out connector: If your TV has an HDMI connector and you have HDMI or component video source devices, use an HDMI cable (not included) to connect it to the AVR's HDMI Monitor Out connector.

Notes on using the HDMI Monitor Out connector:

- When connecting a DVI-equipped display to the HDMI Monitor Out connector, use an HDMI-to-DVI adapter and make a separate audio connection.
- Make sure the HDMI-equipped display is HDCP-compliant. If it isn't, do not connect it via HDMI; use an analog video connection instead and make a separate audio connection.

HDMI Input connectors: The HDMI (High-Definition Multimedia Interface®) feature is a connection for transmitting digital audio and video signals between devices. If your source devices have HDMI connectors, using them will provide the best possible video and audio performance quality. Since the HDMI cable carries both digital video and digital audio signals, you do not have to make any additional audio connections for devices you connect via HDMI connections. See *Connect Your Source Devices*, on page 13, for more information.

Composite Video Monitor Out connector: If your TV or video display does not have an HDMI connector, or if your TV does have an HDMI connector *but you are connecting some source devices with only composite video connectors*, use a composite video cable (not included) to connect the AVR's Composite Video Monitor Out connector to your TV's composite video input connector.

DVD Component Video Input connector: If your Blu-ray Disc™ or DVD player does not have an HDMI connector but does have a component video connector, using the component video connector will provide superior video performance. You will also need to make an audio connection from the player to the AVR.

Digital Audio Input connectors: If your non-HDMI source devices have digital outputs, connect them to the AVR's digital audio connectors. NOTE: Make only one type of digital connection (HDMI, optical or coaxial) from each device. See *Connect Your Source Devices*, on page 13, for more information.

Video 2 Out connector: Connect an analog video recorder's video input connector to the AVR's Video 2 Out connector. You can record any composite video input signal. NOTE: To record the audio and video from the source device, connect the AVR's Video 2 Out Analog Output connectors to the analog video recorder's audio inputs.

Composite Video Input connectors: Use composite video connectors for video source devices that don't have HDMI or component video connectors. You will also need to make an audio connection from the source device to the AVR. See *Connect Your Source Devices*, on page 13, for more information.

IR Remote In/Out connectors: When the IR Sensor on the front panel is blocked (such as when the AVR is installed inside a cabinet), connect an optional IR receiver to the IR Remote In connector. The IR Remote Out connector may be connected to the IR input of a compatible product to enable remote control through the AVR. See *Connect IR Equipment*, on page 15, for more information.

The Bridge IIP connector: Connect an optional Harman Kardon The Bridge IIP docking station to this connector. Insert the plug until it snaps into place in the connector. IMPORTANT: Connect The Bridge IIP only with the AVR's power turned off. See *Connect The Bridge IIP*, on page 15, for more information.

Subwoofer connector: Connect this jack to a powered subwoofer with a line-level input. See *Connect Your Subwoofer*, on page 13, for more information.

Analog Audio Input/Output connectors: Use the AVR's Analog Audio Input/Output connectors for source devices that don't have HDMI or digital audio connectors. Use the Video 2 Out and Tape Out connectors to connect to the audio inputs of a VCR and tape deck. See *Connect Your Source Devices*, on page 13, for more information.

Speaker connectors: Use two-conductor speaker wire to connect each set of terminals to the correct speaker. See *Connect Your Speakers*, on page 13, for more information.

Optical Digital Output connector: Connect a digital audio recorder's optical digital input to the AVR's Optical Digital Output connector. You can record both coaxial and optical digital PCM audio signals. (Dolby Digital and DTS® bitstreams are not available for recording.)

Main Power switch: This mechanical switch turns the AVR's power supply on or off. It is usually left on and cannot be turned on or off using the remote control.

12V Trigger connector: This connector provides 12V DC whenever the AVR is on. It can be used to turn on and off other devices such as a powered subwoofer.

AC Input connector: After you have made all other connections, plug the supplied AC power cord into this receptacle and into an unswitched wall outlet.

System Remote Control Functions

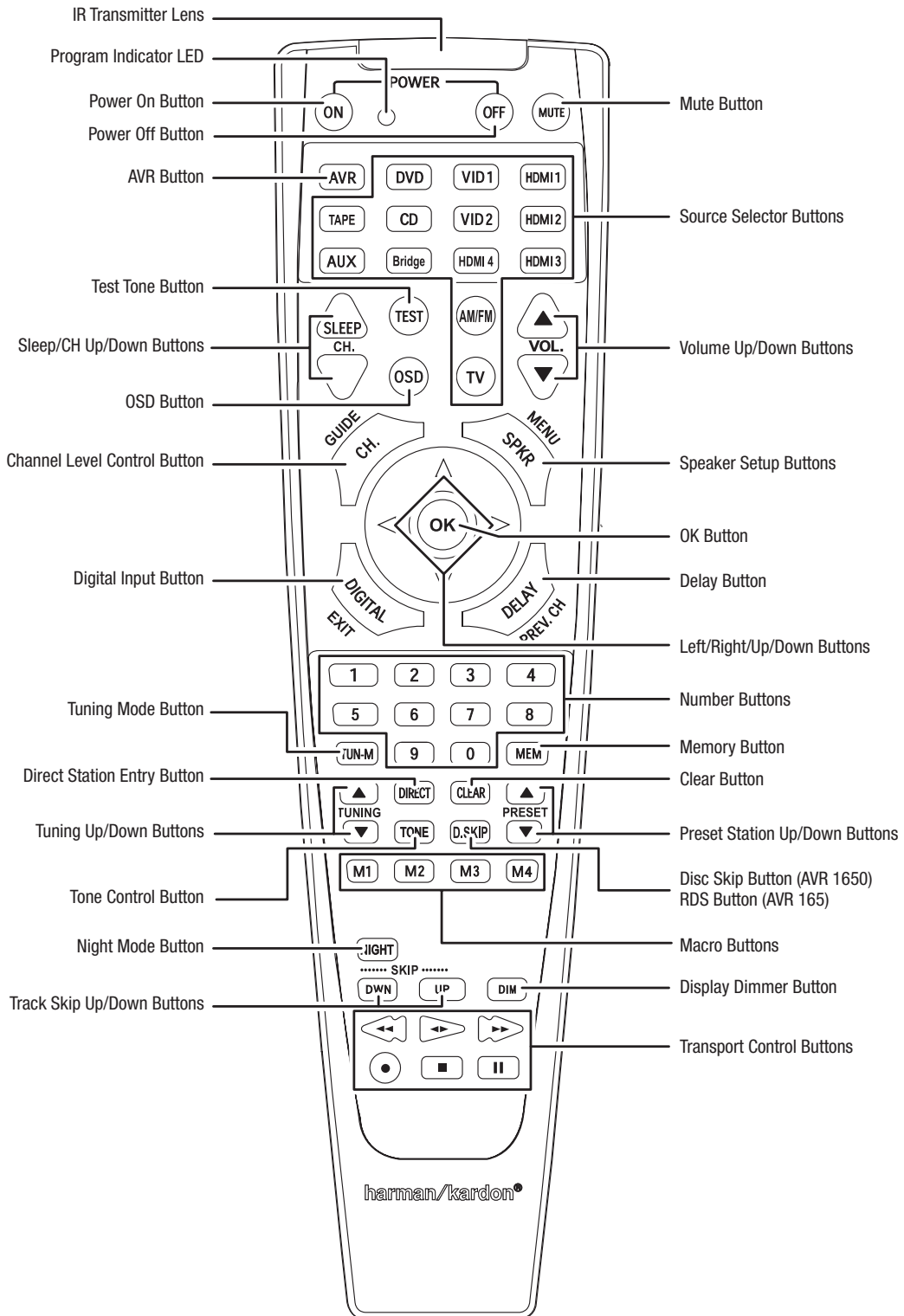

System Remote Control Functions, continued

In addition to controlling the AVR, the AVR remote is capable of controlling nine other devices, including an iPod/iPhone device docked in a The Bridge IIP docking station connected to the AVR. During the installation process, you may program the codes for each of your source components into the remote. (See *Program the Remote to Control Your Source Devices and TV*, on page 16, for programming information.) To operate a component, press its Source Selector button to change the remote's control mode.

A button's function depends on which component is being controlled. See Table A10 in the Appendix for listings of the functions for each type of component. Most of the buttons on the remote have dedicated functions, although the precise codes transmitted vary depending on the specific device being controlled. Due to the wide variety of functions for various source devices, we have included only a few of the most often-used functions on the remote: alphanumeric keys, transport controls, television-channel control, menu access and power on and off. To return the remote to the AVR control mode at any time, press the AVR button.

IR Transmitter lens: As buttons are pressed on the remote, infrared codes are emitted through this lens.

Program Indicator LED: This LED lights up to indicate various procedures when the remote is in the Programming mode.

Power On/Off buttons: Press these buttons to turn the AVR or the device being controlled on and off. The Main Power switch on the AVR's rear panel must be on for this button to turn the AVR on and off.

Mute button: Press this button to mute the AVR's speaker-output connectors and Headphone jack. To restore the sound, press this button or adjust the volume.

AVR button: Press this button to switch the remote's control mode to operate the AVR.

Source Selector buttons: Press one of these buttons to select a source device, e.g., DVD, AM/FM radio, etc. This action will also turn on the AVR and switch the remote's control mode to operate the selected source device. **NOTE:** The first press of the Radio Source Selector button switches the AVR to the last-used tuner band (AM or FM). Each successive press changes the band.

Test Tone button: Press this button to activate the test tone for calibrating channel volume levels by ear.

Sleep button/Channel Up/Down buttons: Press the Sleep button to activate the sleep timer, which turns off the AVR after a programmed period of time of up to 90 minutes. The Channel Up/Down buttons have no effect on the AVR but are used to change channels on TVs and some video sources.

Volume Up/Down buttons: Press these buttons to raise or lower the volume.

OSD button: Press this button to activate the on-screen display menu system.

Channel Level Control button: Press this button to activate the individual channel-level adjustment. It lets you easily change the channel balance to suit different programs or seating arrangements. See *Manual Speaker Setup*, on page 21, for more information.

Speaker Setup button: Press this button to configure which speakers are included in your system. See *Manual Speaker Setup*, on page 21, for more information.

OK button: This button is used to select items from the menu system.

Digital Input button: Press this button to select the specific digital audio input (or analog audio input) to which the current source is connected.

Delay button: Pressing this button lets you adjust two different types of delay settings (use the Up/Down buttons to cycle through the settings):

- **AV Sync:** This setting lets you resynchronize the audio and video signals from a source to eliminate a "lip sync" problem. Lip-sync issues can occur when the video portion of a signal undergoes additional processing in either the source device or the video display. Use the Left/Right buttons to delay the audio by up to 180ms.
- **Front L/Center/Front R/Surr R/Surr L/Subwoofer:** These settings let you set the delay for each speaker to compensate for the different distances they may be from the listening position. Use the Up/Down buttons to cycle through each of the system's speakers, and use the Left/Right buttons to set the distance each speaker is from the listening position. See *Manual Speaker Setup*, on page 21, for more information.

Left/Right/Up/Down buttons: These buttons are used to navigate the menu system.

Number buttons: Use these buttons to enter numbers for radio-station frequencies or to select station presets.

Tuning Mode button: Press this button to toggle the radio between manual (one frequency step at a time) and automatic (seeks frequencies with acceptable signal strength) tuning mode. It also toggles between stereo and mono modes when an FM station is tuned in.

Memory button: To save the currently tuned radio station as a preset, press this button, then a Number button.

Direct Station Entry button: Press this button before using the Number buttons to enter a radio station frequency.

Clear button: Press this button to clear a radio station frequency you have started to enter.

Tuning Up/Down buttons: Press these buttons to tune a radio station. Depending on whether the tuning mode has been set to manual or automatic, each press will either change one tuning frequency increment at a time or seek the next higher or lower station with acceptable signal strength.

Preset Station Up/Down buttons: Press these buttons to cycle through your preset radio stations.

Tone Control button: Press this button to access the bass and treble controls. Use the OK button to select an adjustment and use the Up/Down buttons to change the settings.

Disc Skip button (AVR 1650): This button is used with some optical disc changers to skip to the next disc.

RDS button (AVR 165): When listening to an FM radio station that broadcasts RDS information, this button activates the various RDS functions.

Night Mode button: Press this button to activate Night mode with specially encoded Dolby Digital discs or broadcasts. Night mode compresses the audio so that louder passages are reduced in volume to avoid disturbing others, while dialogue remains intelligible. Each press of the button advances through the following settings:

- **Off:** No compression is applied. Loud passages in the program remain as they were recorded.
- **Mid:** Loud passages in the program are reduced moderately in volume.
- **Max:** Loud passages in the program are reduced more in volume.

Macro buttons: These buttons may be programmed to execute a series of up to 19 commands with a single button press. They are useful for programming the command to turn on or off all of your components or for accessing specialized functions for a different component from the one that you are currently operating. See *Programming Macro Commands*, on page 24, for information about programming macros.

Track Skip Up/Down buttons: These buttons have no effect on the AVR but are used with many source components to change tracks or chapters.

Display Dimmer button: Press this button to dim the AVR's front-panel display partially or fully.

Transport Control buttons: These buttons have no effect on the AVR but are used to control many source components. By default, when the remote is operating the AVR, these buttons will control a Harman Kardon Blu-ray Disc player or DVD player.

Introduction to Home Theater

This introductory section will help you to familiarize yourself with some basic concepts unique to multichannel surround-sound AVRs, which will make it easier for you to set up and operate your AVR.

Typical Home Theater System

A home theater typically includes an audio/video receiver (AVR), which controls the system and supplies amplification for the loudspeakers; a disc player; a source component for television broadcasts (cable box, satellite dish AVR, HDTV tuner or antenna connected to the TV); a TV or video display; and multiple loudspeakers.

Multichannel Audio

The main benefit of a home theater system is its ability to produce “surround sound.” Surround sound uses multiple speakers and amplifier channels to immerse you in the audio/video presentation for a dramatically increased sense of realism.

Your AVR can have up to five main speakers connected directly to it, plus a subwoofer. Each main speaker is powered by its own amplifier channel inside the AVR. A system with more than two speakers is called a multichannel system. The different main speaker types in a home theater system are:

- **Front Left and Right:** The front left and right speakers are used as in a 2-channel system. In many surround-sound modes, these speakers are secondary, while the main action, especially dialogue, is reproduced by the center speaker.
- **Center:** When you are watching movies and television programs, the center speaker reproduces most of the dialogue and other soundtrack information that occurs on the screen, anchoring it with the picture. When you are listening to a musical program, the center speaker helps to create a seamless front soundstage, creating a more realistic “you-are-there” listening experience.
- **Surround Left and Right:** The surround left and right speakers produce ambient sounds that help create a realistic and immersive surround-sound environment. They also help recreate directional sound effects such as aircraft flyovers.

Many people expect the surround speakers to play as loudly as the front speakers. Although you will calibrate all of the speakers in your system to sound equally loud at the listening position, most artists use the surround speakers for ambient effects only, and they create their programs to steer relatively little sound to these speakers.

- **Subwoofer:** A subwoofer is designed to play only the lowest frequencies (the deep bass). It augments smaller, limited-range main speakers that are usually used for the other channels. Many digital-format programs, such as movies recorded in Dolby Digital, contain a low-frequency effects (LFE) channel that is directed to the subwoofer. The LFE channel packs the punch of a rumbling train or airplane, or the power of an explosion, adding realism and excitement to your home theater. Some people use two subwoofers for additional power and for even distribution of the sound.

Surround Modes

There are different theories as to the best way to present surround sound and to distribute the individual channel information to the surround-sound system’s speakers. A variety of algorithms have been developed in an effort to recreate the way we hear sounds in the real world, resulting in a rich variety of options. Several companies have developed different surround-sound technologies, all of which can be accurately reproduced by your AVR:

- **Dolby Laboratories:** Dolby TrueHD, Dolby Digital Plus, Dolby Digital, Dolby Digital EX, Dolby Pro Logic II.
- **DTS:** DTS-HD™ High Resolution Audio, DTS-HD Master Audio™, DTS, DTS 96/24™.
- **HARMAN International:** Logic 7, HARMAN virtual speaker, HARMAN headphone.
- **Stereo Modes:** 2-channel stereo and 5-channel stereo.

Appendix Table A9, on page 31, contains detailed explanations of the different surround-sound options available on your AVR. Digital surround-sound modes, such as Dolby Digital and DTS systems, are available only with specially encoded programs, such as those available via HDTV, DVD and Blu-ray Disc media and digital cable or satellite television. Other surround modes may be used with digital and analog signals to create a different surround presentation or to use a different number of speakers. Surround-mode selection depends upon the number of speakers in your system, the programs you are watching or listening to, and your personal tastes.

Place Your Speakers

Determine the locations for your system’s speakers according to their manufacturer’s directions and the layout of your listening room. Use the illustration below as a guide for 5.1-channel systems.

To create the most realistic surround-sound environment possible, you should place your speakers in a circle with the listening position at its center. You should angle each speaker so it directly faces the listening position. Use the diagram below as a guide.

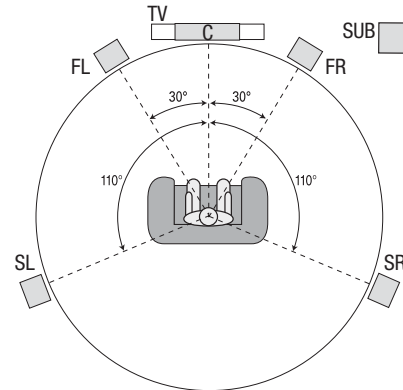

Placing the Left, Center and Right Speakers

Place the center speaker either on top of, below or mounted on the wall above or below the TV or video-display screen. Place the front left and right speakers along the circle, about 30 degrees from the center speaker and angled toward the listener.

Place the front left, front right and center speakers at the same height, preferably at about the same height as the listener’s ears. The center speaker should be no more than 2 feet (0.6m) above or below the left/right speakers. If you’re using only two speakers with your AVR, place them in the front left and front right positions.

Placing the Surround Speakers

You should place the left and right surround speakers approximately 110 degrees from the center speaker, slightly behind and angled toward the listener. Alternatively, you can place them behind the listener, with each surround speaker facing the opposite-side front speaker. You should place the surround speakers 2 feet – 6 feet (0.6m – 1.8m) higher than the listener’s ears.

NOTE: Your AVR will sound its best when the same model or brand of loudspeaker is used for all positions.

Placing the Subwoofer

Because a room’s shape and volume can have a dramatic effect on a subwoofer’s performance, it is best to experiment with placement so that you will find the location that produces the best results in your particular listening room. With that in mind, these rules will help you get started:

- Placing the subwoofer next to a wall generally will increase the amount of bass in the room.
- Placing the subwoofer in a corner generally will maximize the amount of bass in the room.
- In many rooms, placing the subwoofer along the same plane as the left and right speakers can produce the best integration between the sound of the subwoofer and that of the left and right speakers.
- In some rooms, the best performance could even result from placing the subwoofer behind the listening position.

A good way to determine the best location for the subwoofer is by temporarily placing it in the listening position and playing music with strong bass content. Move around to various locations in the room while the system is playing (putting your ears where the subwoofer would be placed), and listen until you find the location where the bass performance is best. Place the subwoofer in that location.

Types of Home Theater System Connections

There are different types of audio and video connections used to connect the AVR to your speakers, your TV or video display, and your source devices. The Consumer Electronics Association has established the CEA® color-coding standard.

Connection Color Guide Table

Analog Audio Connection	Color
Front Left/Right	White/Red
Center	Green
Surround Left/Right	Blue/Gray
Subwoofer	Purple
Digital Audio Connection	Color
Coaxial (input or output)	Orange
Optical Input	Black
Optical Record Output	Gray
Analog Video Connection	Color
Component Video	Red/Green/Blue
Composite Video	Yellow

Speaker Connections

Speaker cables carry an amplified signal from the AVR's speaker terminals to each loudspeaker. Each cable contains two wire conductors, or leads, that are differentiated in some way, such as with colors or stripes.

The differentiation helps you maintain proper polarity, without which your system's low-frequency performance can suffer. Each speaker is connected to the AVR's speaker-output terminals using two wires, one positive (+) and one negative (-). Always connect the positive terminal on the speaker, which is usually colored red, to the positive terminal on the AVR, which is colored as indicated in the Connection Color Guide Table, above. The negative terminals on the speakers and the AVR are black.

Your AVR uses binding-post speaker terminals that can accept bare-wire cables or banana plugs. Bare-wire cables are installed as shown below:

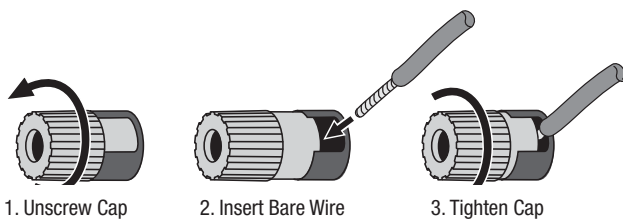

Banana plugs are inserted into the hole in the middle of the terminal cap, as shown below:

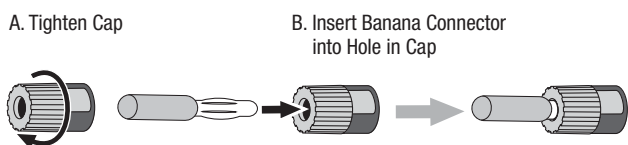

Always connect the colored (+) terminal on the AVR to the (+) terminal on the speaker (usually red), and the black (-) terminal on the AVR to the (-) terminal on the speaker (usually black).

IMPORTANT: Make sure the (+) and (-) bare wires do not touch each other or the other terminal. Touching wires can cause a short circuit that can damage your AVR or amplifier.

Subwoofer Connections

The subwoofer is a speaker dedicated to reproducing only the low (bass) frequencies, which require more power. To obtain the best results, most speaker manufacturers offer powered subwoofers that contain their own amplifiers. Use a single RCA audio cable (not included) to make a line-level (non-amplified) connection from the AVR's Subwoofer connector to a corresponding input jack on the subwoofer.

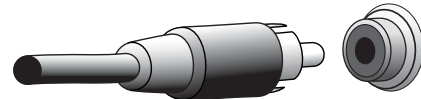

Although the AVR's purple subwoofer output looks similar to a full-range analog audio jack, it is filtered so that only the low frequencies pass through it. Don't connect this output to any device other than a subwoofer.

Source Device Connections

Audio and video signals originate in source devices (components where a playback signal originates) such as your Blu-ray Disc or DVD player, CD player, DVR (digital video recorder) or other recorder, tape deck, game console, cable or satellite television tuner, iPod or iPhone (docked in an optional The Bridge III P docking station) or MP3 player. The AVR's FM/AM tuner also counts as a source, even though no external connectors are needed other than the AVR's FM and AM antennas. Separate connectors are required for the audio and video portions of the source device's signal, except for digital HDMI connectors. The types of connectors you use will depend upon the capabilities of the source device and of your TV or video display.

Digital Audio Connections – HDMI

There are two types of audio connections – digital and analog. Digital audio signals are required for listening to sources encoded with digital surround modes, such as Dolby Digital and DTS, or for uncompressed PCM digital audio. Your AVR has three types of digital audio connectors: HDMI, coaxial and optical. Do not use more than one type of digital audio connector for each source device. However, it's okay to make both analog and digital audio connections to the same source.

Your AVR is equipped with four rear-panel HDMI input connectors and one HDMI monitor output connector. HDMI technology enables digital audio and video information to be carried using a single cable, delivering the highest quality picture and sound. If your TV or video-display device has an HDMI input connector, make a single HDMI connection from each source device to the AVR. Usually, a separate digital audio connection is not required.

The AVR's HDMI Monitor Output connector contains an Audio Return Channel (ARC) that carries a digital audio signal from your TV or video display back to the AVR. It allows you to listen to HDMI devices that are connected directly to your TV (such as an Internet connection) without making an additional connection from the device to the AVR. The ARC signal is active when the TV source is selected. See *System Setup*, on page 23, for more information.

The HDMI connector is shaped for easy plug-in (see illustration, below), and HDMI cable runs are limited to about 10 feet (3m). If your video display has a DVI input and is HDCP-compliant, use an HDMI-to-DVI adapter (not included), and make a separate audio connection.

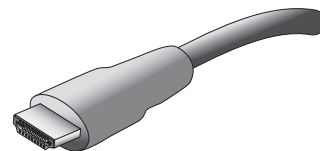

Digital Audio Connections – Coaxial

Coaxial digital audio jacks are usually color-coded orange. Although they look like standard RCA-type analog jacks, you should not connect coaxial digital audio outputs to analog inputs or vice versa.

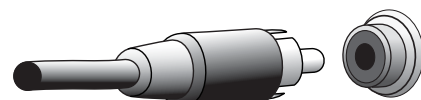

Digital Audio Connections – Optical

Optical digital audio connectors are normally covered by a shutter to protect them from dust. The shutter opens as the cable is inserted. Optical input connectors are color-coded using a black shutter, while optical outputs use a gray shutter.

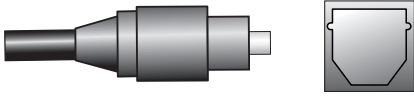

Analog Audio Connections

Two-channel analog connections require a stereo audio cable, with one connector for the left channel (white) and one for the right channel (red). These two connectors are attached to each other.

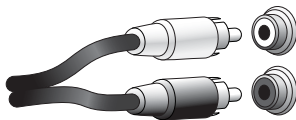

For source devices that have both digital and analog audio outputs, you may make both connections.

The analog connections also feed the Analog Record Output connectors. You may record materials from Blu-ray Disc recordings, DVDs or other copy-protected sources using only analog connections. Remember to comply with all copyright laws if you choose to make a copy for your own personal use.

The Bridge IIP Connection

Your AVR includes a proprietary, dedicated connector for a The Bridge IIP docking station (available separately) for the iPod or iPhone.

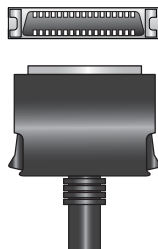

Video Connections

Many source devices output both audio and video signals (e.g., Blu-ray Disc, DVD player, cable television box, HDTV tuner, satellite box, VCR, DVR). In addition to an audio connection as described above, make a video connection for each of these source devices. Make only one type of video connection for each device.

Digital Video Connections

If you have already connected a source device to one of the AVR's HDMI input connectors, you have automatically made a video connection for that device, since the HDMI cable carries both digital audio and digital video signals.

Analog Video Connections – Composite Video

Your AVR uses two types of analog video connections: composite video and component video.

Composite video is the basic connection most commonly available. Both the chrominance (color) and the luminance (intensity) components of the video signal are transmitted using a single cable. The jack is usually color-coded yellow and looks like an analog audio jack. Do not connect a composite video jack to an analog audio or coaxial digital audio jack, or vice versa.

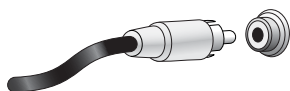

Analog Video Connections – Component Video

Component video separates the video signal into three components – one luminance (“Y”) and two sub-sampled color signals (“Pb” and “Pr”) – that are transmitted using three separate cables that are color-coded green (Y), blue (Pb) and red (Pr). Component video cables that join three separate green, blue and red connectors into a single cable are sold separately.

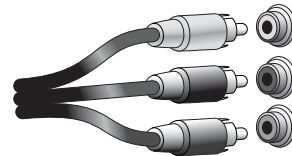

If your TV or video display has an HDMI connector, we recommend it for the best quality connection. Your AVR converts component analog video input signals to the HDMI format, upscaling them to high-definition 1080p resolution.

Radio Connections

Your AVR uses separate terminals for the included FM and AM antennas. The FM antenna uses a 75-ohm F-connector.

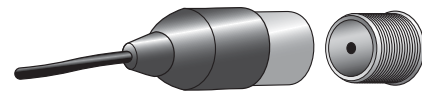

The AM antenna connector uses spring-clip terminals. After assembling the antenna as shown below, press the levers to open the connectors, insert the bare wires into the openings, and release the levers to secure the wires. The antenna wires are not polarized, so you can insert either wire into either connector.



USB Port

The USB port on your AVR is used for firmware upgrades. If an upgrade for the AVR's operating system is released in the future, you will be able to download it to the AVR using this port. Complete instructions will be provided at that time.

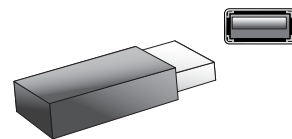

IMPORTANT: Do not connect a PC or other USB host/controller to the AVR's USB port, or you may damage both the AVR and the other device.

Making Connections

CAUTION: Before making any connections to the AVR, ensure that the AVR's AC cord is unplugged from the AVR and the AC outlet. Making connections with the AVR plugged in and turned on could damage the speakers.

Connect Your Speakers

After you have placed your loudspeakers in the room as explained in *Place Your Speakers*, on page 10, connect each speaker to its color-coded terminal on the AVR as explained in *Speaker Connections*, on page 11. Connect the speakers as shown in the illustration.

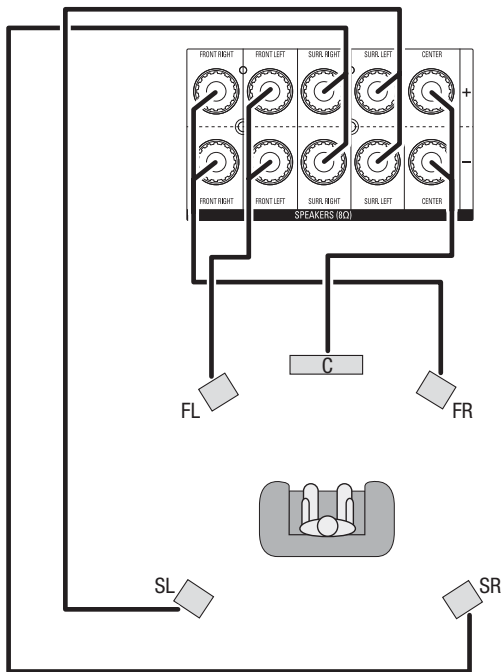

Connect Your Subwoofer

Use a single RCA audio cable to connect the AVR's Subwoofer Pre-Out connector to your subwoofer. Consult your subwoofer's user manual for specific information about making connections to it.

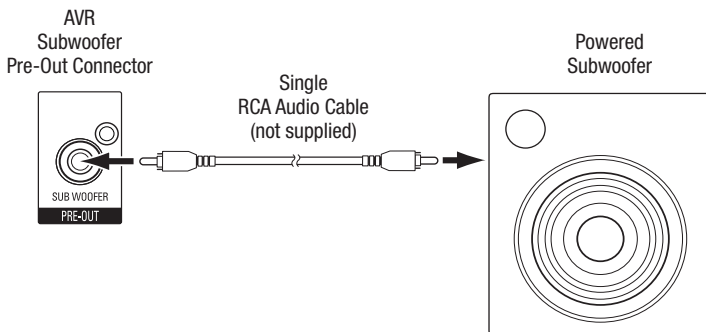

Connect Your TV or Video Display

HDMI Monitor Out connector

If your TV has an HDMI connector and you have HDMI or component video source devices, use an HDMI cable (not included) to connect your TV to the AVR's HDMI Monitor Out connector. It will provide the best possible picture quality.

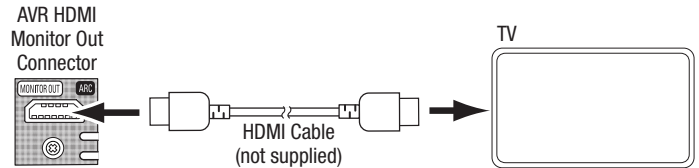

Composite Video Monitor Out connector

If your TV does not have an HDMI connector, or if your TV does have an HDMI connector but you are connecting some source devices with only composite video connectors, use a composite video cable (not included) to connect the AVR's Composite Monitor Out connector to your TV's composite video connector.

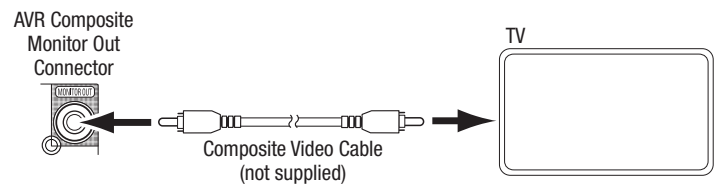

Connect Your Source Devices

Source devices are components where a playback signal originates, such as a Blu-ray Disc or DVD player, or a cable, satellite or HDTV tuner. Your AVR has several different types of input connectors for your audio and video source devices: HDMI, component video, composite video, optical digital audio, coaxial digital audio and analog audio. The connectors are labeled for the types of source devices you are most likely to connect.

Each of your AVR's source buttons is assigned to an HDMI connector or an analog audio input connector (listed in the "AVR Source Button/Analog Audio Connector" column of the table below). To provide you flexibility for connecting and configuring your system, we have designed the AVR so that you can assign the digital audio inputs to any of the video AVR sources.

As you connect your various source components, fill out the "Source Device Connected" column in the following table – it will make it easier for you to assign the digital audio input connectors and component video connector later in the setup process.

AVR Source Button/ Analog Audio Connector	Recommended Source Device Type	Source Device Connected	Digital Audio Input Connector Assigned
Video 1	Cable or Satellite Tuner		
Video 2	DVD Recorder or VCR		
DVD	Blu-ray Disc or DVD Player		
CD	CD Player		
Tape	Cassette Deck or Audio Recorder		
Aux	Portable Media Palyer		
The Bridge IIIP	iPod/iPhone Device		
AVR Source Button/ HDMI Connector	----	Source Device Connected	Digital Audio Input Connector Assigned
HDMI 1	----		
HDMI 2	----		
HDMI 3	----		
HDMI 4	----		

Input Connections and Source Buttons

HDMI devices

If any of your source devices have HDMI connectors, using those connectors will provide the best possible video and audio performance quality. Since the HDMI cable carries both digital video and digital audio signals, you do not have to make any additional audio connections for devices you connect via HDMI cables, although you can assign one of the digital audio connectors to one of the HDMI inputs.

If you have a TV or other source device equipped with the HDMI Audio Return Channel function, you can feed its sound to the AVR via the HDMI Monitor Out connector's Audio Return Channel, and it will not require additional audio connections to the AVR.

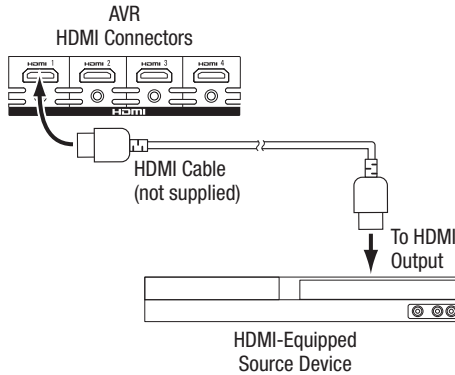

Component video devices

If your Blu-ray Disc or DVD player does not have an HDMI connector but does have a component video connector, using the component video connector will provide superior video performance. You will also need to make an audio connection from the player to the AVR.

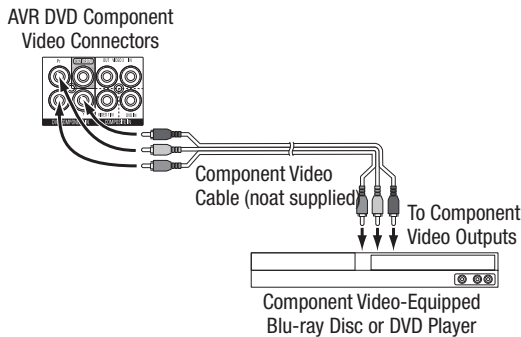

Composite video devices

You will need to make composite video connections from your source devices that do not have HDMI or component video connectors. You will also need to connect the source device's analog audio outputs to the AVR's corresponding analog audio connectors.

IMPORTANT: If you connected your Blu-ray Disc or DVD player to the AVR's DVD Component Video Input connectors, do not connect a source device to the AVR's DVD Composite Video Input connector.

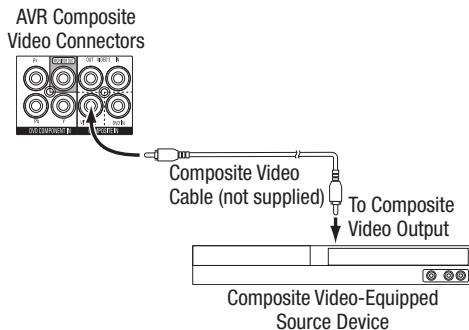

Optical digital audio devices

If your source devices have optical digital outputs, connect them to the AVR's Optical Digital Audio connectors. **NOTE:** Make only one type of digital connection (HDMI, optical or coaxial) from each device.

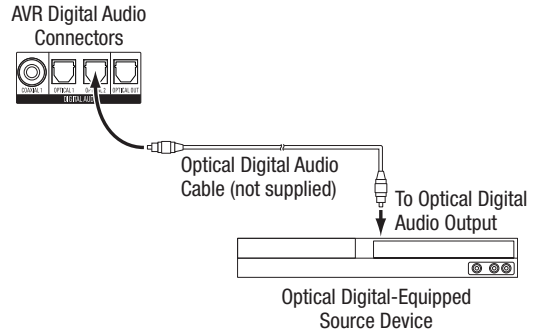

Coaxial digital audio devices

If your source devices have coaxial digital outputs, connect them to the AVR's Coaxial Digital Audio connectors. **NOTE:** Make only one type of digital connection (HDMI, optical or coaxial) from each device.

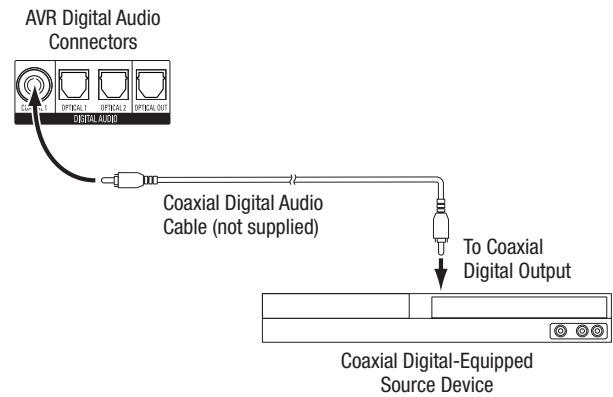

Analog audio devices

Make analog audio connections from your source devices that do not have HDMI or digital audio connectors. If you're connecting video sources to the DVD, Video 1 or Video 2 audio inputs, you must also connect the source device's composite video output to the corresponding composite video connector.

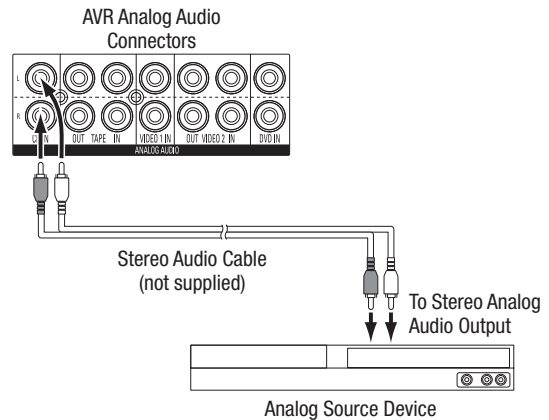

Audio recorders

Connect an analog audio recorder's inputs to the AVR's analog audio Tape Out connectors. You can record any analog audio input signal.

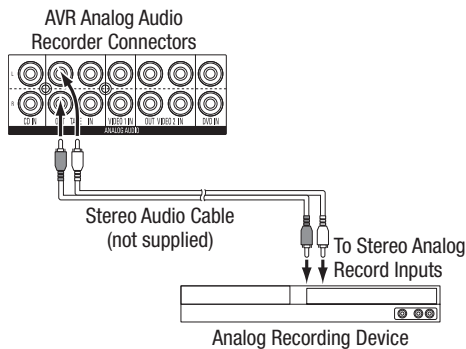

You can connect the AVR's Optical Digital Output connector to a digital audio recorder's optical digital input connector. You can record both coaxial and optical digital input signals.

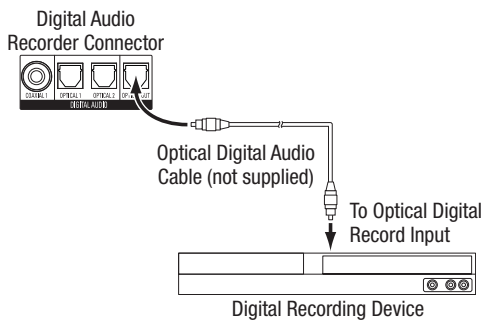

Video recorders

Connect an analog video recorder's video input connector to the AVR's Video 2 Out Composite Video connector, and its audio input connectors to the AVR's Video 2 Out Analog Audio connectors. You can record any composite video signal.

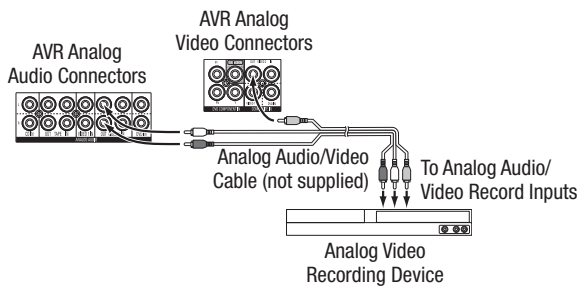

Connect The Bridge IIP

Connect an optional The Bridge IIP to the AVR's The Bridge IIP connector. Insert the plug until it snaps into place in the connector. **IMPORTANT: Connect The Bridge IIP only with the AVR's power turned OFF.**

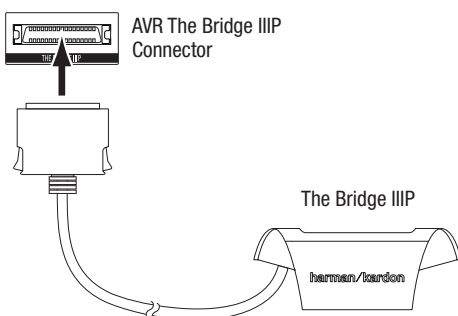

Connect the Radio Antennas

- Connect the supplied FM antenna to the AVR's FM 75Ω Radio Antenna connector. For the best reception, extend the FM antenna as far as possible.
- Bend and fold the base of the supplied AM antenna as shown and connect the antenna wires to the AVR's AM and Gnd connectors. (You can connect either wire to either connector.) Rotate the antenna as necessary to minimize background noise.

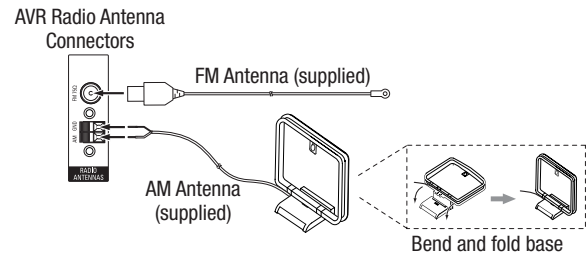

Connect IR Equipment

The AVR's Remote IR Input and Output connectors let you remotely control the AVR in a variety of situations:

- When you place the AVR inside a cabinet or facing away from the listener, connect an external IR receiver, such as the Harman Kardon HE 1000 (available separately), to the AVR's IR Remote In connector.

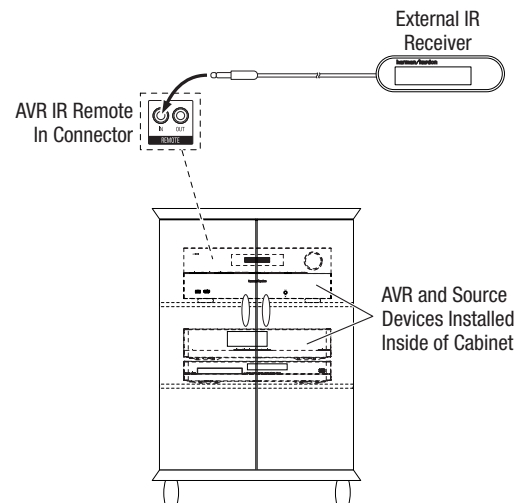

- If any source devices are equipped with a compatible IR input connector, use a 1/8-inch (3.5mm) mini-plug interconnect cable (not included) to connect the AVR's IR Remote Out jack to the source device's IR input connector.

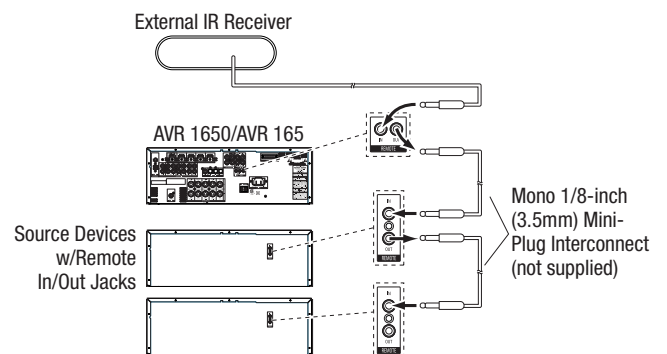

To control more than one source device through the AVR's IR Remote Out connector, connect all sources in "daisy chain" fashion, connecting each device's IR output connector to the next device's IR input connector, starting with the AVR.

Connect the 12V Trigger Output

If your system has equipment that can be controlled by a DC trigger signal, connect it to the AVR's 12V Trigger connector with a mono 1/8-inch (3.5mm) mini-plug interconnect cable. The AVR will supply a 12V DC (100mA) trigger signal at this connection whenever it is powered on.

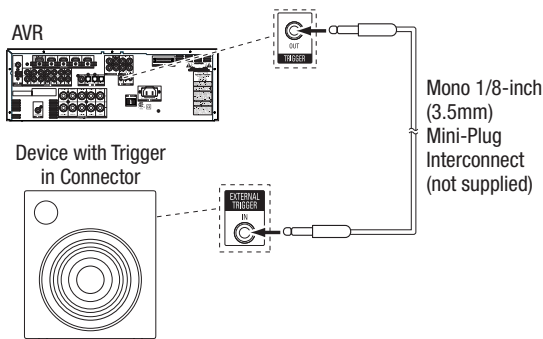

Connect to AC Power

Connect the AC power cord to the AVR's AC Input connector and then to a working AC power outlet.

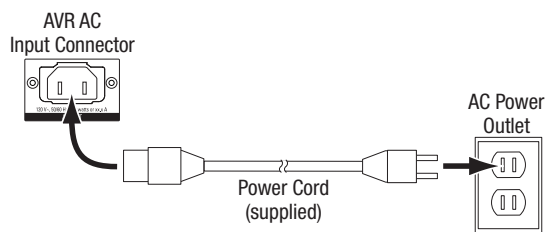

Set Up the Remote Control

Install the Batteries in the Remote Control

Remove the remote control's battery cover, insert the three supplied AAA batteries as shown in the illustration, and replace the battery cover.

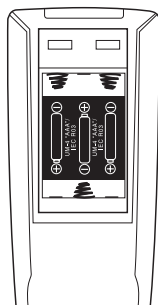

NOTE: Remove the protective plastic from the AVR's front panel to keep it from reducing the remote control's effectiveness.

Program the Remote to Control Your Source Devices and TV

In addition to using the remote to control the AVR itself and the AM/FM radio, you can program the remote to control up to nine additional audio/video source devices plus your TV. The remote is also ready to operate your iPod or iPhone device when the device is docked in a connected The Bridge IIP (not included).

Once you have programmed the remote, you can switch the remote's control mode to access the functions for a particular source device by pressing the remote's Source Selector button for that device. To control the AVR, press the remote's AVR button.

Before you begin programming the remote, review the connections you filled in on the *Input Connections and Source Buttons* table on page 13. The Source Selector buttons are assigned to the components that you listed in the table's "Source Device Connected" column.

1. Turn on the source device you want to program the remote to control.
2. Look up the code numbers for the device in Tables A11 – A17 in the Appendix. Write all the applicable code numbers in a convenient place.
3. Press and hold the Source Selector button for that source device until the Program Indicator LED on the remote starts to flash, then release it. (This procedure places the remote in the Programming mode.)

NOTE: If you're programming one of the four HDMI source buttons, after pressing the HDMI button you must also press the Source Selector button for the type of device that will be controlled:

- Press DVD to control a DVD player.
 - Press VID1 to control a VCR, DVR or Harman Kardon digital media center.
 - Press VID2 to control a cable or satellite set-top box.
4. Aim the remote at the source device and use the remote's Number buttons to enter a code number from Step 2, above.
 - a) If the device turns off, press the Source Selector button again to save its code. The Source Selector button will flash, and the remote will exit the Programming mode.
 - b) If the device does not turn off, enter another code number.
 - c) If you run out of code numbers for a device, you can search through all of the codes in the remote's library for devices of its type by pressing the Up or Down button repeatedly until the device turns off. When it does, press the Source Selector button to save the code.
 5. Check that other functions control the device correctly. Sometimes manufacturers use the same Power code for several models, while other function codes vary. Repeat this process until you've programmed a satisfactory code set that operates most of the device's functions.
 6. If you searched through the remote's code library to find the code, you can find out which code number you have programmed by pressing and holding the Source Selector button to re-enter the Programming Mode. Then press the remote's OK button, and the Program Indicator LED will flash in the code sequence. One flash represents "1," two flashes represent "2," and so forth. A series of quick flashes represents "0." Record the code number programmed for each device in Table A7 in the Appendix.

Repeat Steps 3 – 6 for each source device you want to control with the AVR remote.

In general, the label for each button on the remote describes the button's function when used to control the AVR. However, the button may perform a very different function when used to control another device. Refer to the *Remote Control Function List*, Table A10 in the Appendix, for each button's functions with the various product types.

You can also program the remote to perform Macros (preprogrammed code sequences that execute many code commands with a single button press) and "punch-through" programming (allowing the remote to operate a device's channel or transport controls when the remote is in another device's mode). See *Advanced Remote Control Programming*, on page 24, for instructions on these functions.

Set Up the AVR

Turn On the AVR

1. Set the rear-panel Main Power switch to "On." (The front-panel Power indicator will glow amber.)
2. Press the front-panel Power button.

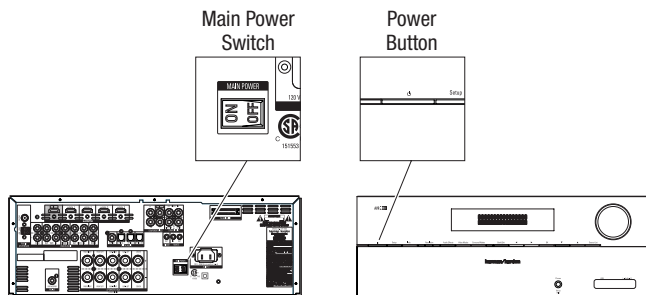

Unless you will not be using the AVR for an extended period of time, leave the Main Power switch set to "On." When the Main Power switch is turned off, any settings you have programmed will be preserved for up to four weeks.

IMPORTANT NOTE: If the PROTECT message ever appears in the Message display, turn off the AVR and unplug it. Check all speaker wires for a short circuit ("+" and "-" wires touching). If none is found, bring the unit to an authorized Harman Kardon service center for inspection and repair before using it again.

Using the On-Screen Menu System

Although it's possible to configure the AVR using only the remote and the front-panel Message display, it is easier to use the on-screen menu system.

To access the menu system, press the OSD button on the remote. The Master menu will appear.

```

**  MASTER MENU  **

▶ INPUT SETUP
  SURROUND MODE
  EzSet/EQ
  MANUAL SETUP
  SYSTEM SETUP
    
```

The Master menu consists of five submenus: Input Setup, Surround Mode, EzSet/EQ, Manual Setup and System Setup.

Use the Up/Down/Left/Right buttons on the remote to navigate the menu system, and press the OK button to select a menu or setting line, or to enter a new setting.

The current menu, setting line or setting will appear in the front-panel Message display, as well as on screen.

To return to the previous menu, navigate to the "Back to Master Menu" line and press the OK button. To exit the menu system, press the OSD button.

Most users should follow the instructions in this *Set Up the AVR* section to configure a basic home theater system. You may return to these menus at any time to make additional adjustments, such as those described in the *Advanced Functions* section, on pages 20 through 24.

Before you begin initial setup, all loudspeakers, a video display and all source devices should be connected to the AVR. You should be able to turn on the AVR and view the Master menu when you press the OSD button. If necessary, reread the *Making Connections* section and the beginning of this section before continuing.

Configure the AVR for Your Speakers

NOTE: If there are fewer than five main speakers in your system, do not use the EzSet/EQ process. Instead, proceed as described in *Manual Speaker Setup*, on page 21.

1. Plug the supplied EzSet/EQ microphone into the AVR's Headphone connector.

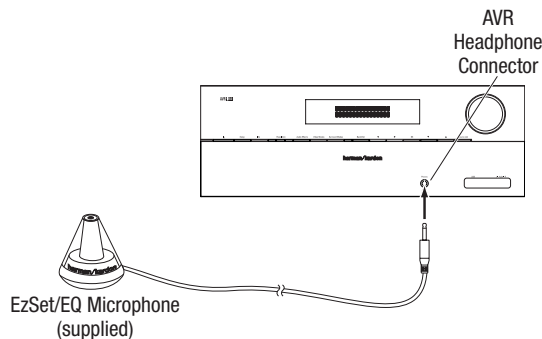

2. Place the microphone at ear height in your listening position. The microphone features a threaded insert on the bottom for mounting on a camera tripod.
3. Set the volume control on your subwoofer to approximately the halfway point.
4. Turn on your TV and select the TV input where you connected the AVR in *Connect Your TV or Video Display*, on page 13.
5. Press the remote control's OSD button. The AVR's on-screen display (OSD) Master Menu will appear on the TV.

```

**  MASTER MENU  **
    
```

```

▶ INPUT SETUP
  SURROUND MODE
  EzSet/EQ
  MANUAL SETUP
  SYSTEM SETUP
    
```

6. Use the remote's arrow and OK buttons to select "EzSet/EQ."

```

*  EzSet/EQ  *
    
```

```

Place Microphone at
listening position and
plug into Headphone Jack
    
```

```

Do you want to start
EzSet/EQ?
    
```

```

▶ YES  NO
    
```

7. Select "YES." The Speaker Configuration menu will appear.
8. Select "5.1."
9. The test will begin. Make sure that the room is quiet while the test noise is playing through the speakers.
10. When the test finishes, select "View Settings" to see the results of the EzSet/EQ process, or select "Done" to exit.

Assign the Digital Audio Connectors

1. Review the input connections you listed on the *Input Connections and Source Buttons* table, on page 13. Note which source devices you connected to the digital audio connectors. (If you did not connect any source devices to the digital audio connectors, you can skip this section.)
2. Turn on your TV and select the TV input where you connected the AVR in *Connect Your TV or Video Display*, on page 13.
3. Press the remote control's OSD button. The AVR's on-screen display (OSD) Master Menu will appear on the TV.

```

**  MASTER MENU  **

```

```

▶ INPUT SETUP
  SURROUND SELECT
  SPEAKER SETUP
  SYSTEM SETUP

```

4. Use the remote's arrow and OK buttons to select "Input Setup." The Input Setup menu will appear.

```

* INPUT SETUP *
▶ SOURCE      : DVD
  TITLE:
  AUDIO IN   : ANALOG
  AUTO POLL  : OFF
  BXR        : OFF
  TONE       : IN
  BASS       : 0
  TREBLE     : 0

  BACK TO MASTER MENU

```

5. For each source device you connected to a digital audio input:

- a) Use the remote's Up and Down arrow buttons to select "Source." Use the Left and Right arrow buttons to change the listed source to one of the sources you connected to a digital audio input connector.
- b) Use the remote's down arrow button to select "Audio In."

```

* INPUT SETUP *
SOURCE      : DVD
TITLE:
▶ AUDIO IN  : OPT 1
  AUTO POLL : ON
  BXR       : OFF
  TONE      : IN
  BASS      : 0
  TREBLE    : 0

  BACK TO MASTER MENU

```

- c) Use the remote's Left and Right arrow buttons to select the digital audio input where you connected the source device.

Additional Input Setup Menu Items

You can also adjust the following settings independently for each source:

Title: You may change the display name for any source (except the radio). This feature may help you to select the correct source device even when you have forgotten which physical connections you used.

1. Move the cursor to the Title line and press the OK button. A block cursor will blink.
2. Use the Up/Down buttons to scroll through the alphabet in upper and lower case, the numbers and many punctuation marks. When you have selected the desired character, press the Right button to move to the next space. Press the Right button twice to leave a blank space.
3. Press the OK button when you have finished.

Auto Poll: The Auto Poll feature is used when both an analog audio and a digital audio connection have been made for one source device. If no digital signal is available, the AVR will automatically switch to the analog input for the source. This situation can occur with some cable or satellite television broadcasts, where some channels are broadcast with digital audio and others with analog audio, or when a DVD player is paused or stopped.

For some sources such as DVD players, the Auto Poll feature is unnecessary and may be undesirable. To turn Auto Poll off, move the cursor to the Auto Poll line and press the Left/Right buttons until Off appears. With Auto Poll turned off, the AVR will check for a signal only at the audio input assigned to the source.

The remaining Input Setup menu items adjust the AVR's audio performance for that source and may be skipped at this time. For most listening, we recommend leaving these settings at their factory defaults, allowing you to enjoy the sound mix created by your favorite movie and music artists.

BXR: Enhances bass performance when playing MP3 tracks. Select On, or leave it at the default Off setting for non-MP3 audio sources.

Tone: This setting determines whether the treble and bass controls are active. When this line is set to Off, the tone controls are out of the circuit, with no changes to the sound. When this line is set to On, the bass and treble frequencies are boosted or cut, depending upon the Bass and Treble settings (see below).

Bass and Treble: Boost or cut the low or high frequencies by up to 10dB by using the Left/Right buttons to change the setting by 2dB at a time.

When you're finished, press the remote's OSD button to turn off the on-screen menu.

Operating Your AVR

Now that you have installed your components and completed a basic configuration, you are ready to begin enjoying your home theater system.

Controlling the Volume

Adjust the volume either by turning the front-panel Volume knob (clockwise to increase volume or counterclockwise to decrease volume) or by pressing the Volume Up/Down buttons on the remote. The volume is displayed as a negative number of decibels (dB) below the 0dB reference point.

0dB is the maximum recommended volume for your AVR. Although it's possible to turn the volume to a higher level, doing so may damage your hearing and your speakers. For certain more dynamic audio materials, even 0dB may be too high, allowing for damage to equipment. Use caution with regard to volume levels.

Muting the Sound

To mute all speakers and the headphones, press the Mute button on the remote. Any recording in progress will not be affected. The MUTE message will appear in the front-panel display as a reminder. To restore the sound, press the Mute button again, or adjust the volume.

Listening Through Headphones

Plug the 1/4-inch stereo plug on a pair of headphones into the front-panel Phones jack for private listening. The default Headphone Bypass mode delivers a conventional 2-channel signal to the headphones. Press the Surround Modes button on the front panel or use the remote and OSD to switch to HARMAN headphone virtual surround processing, which emulates a 5.1-channel speaker system. No other surround modes are available for the headphones.

Selecting a Source

There are two different ways to select a source:

- Press the front-panel Source Select buttons.
- Directly select any source by pressing its Source Selector button on the remote.

The AVR selects the audio and video inputs assigned to the source and any other settings you made during setup.

The source name, the audio and video inputs assigned to the source, and the surround mode will appear on the front panel.

Video Troubleshooting Tips

If there is no picture:

- Check the source selection.
- Check all connections for a loose or incorrect connection.
- Check the video-input selection on the TV/display device.

Additional Tips for Troubleshooting HDMI Connections

- Turn off all devices (including the TV, the AVR and any source components).
- Unplug the HDMI cables, starting with the cable between the AVR and the TV, and continuing with the cables between the AVR and each source device.
- Carefully reconnect the cables from the source devices to the AVR. Connect the cable from the AVR to the TV last.
- Turn on the devices in this order: TV, AVR, source devices.

NOTE: Depending upon the particular components involved, the complexity of the required communication between HDMI components may cause delays of up to a minute in the completion of some actions, such as input switching or switching between SD and HD channels.

Listening to FM and AM Radio

Select the AM/FM source. Use the Tuning Up/Down buttons to tune a station, which will be shown on the front-panel display and the TV screen.

The AVR defaults to automatic tuning, meaning each press of the Tuning Up/Down buttons scans until a station with acceptable signal strength is found. To switch to manual tuning, in which each press of a Tuning button steps through a single frequency increment, press the Tuning Mode button. Each press of the Tuning Mode button toggles between the automatic and manual tuning modes.

Once you have tuned an FM station, toggling the Tuning Mode setting also switches the radio between stereo and monaural reception. (Mono reception may improve reception of weaker stations.)

Preset Stations

A total of 30 stations (AM and FM combined) may be stored as presets. When the desired station has been tuned in, press the Memory button on the remote, and two dashes will flash on the front-panel Message display. Use the Number buttons to enter the desired preset number.

To tune a preset station, press the Preset Up/Down buttons or enter the preset number using the Number buttons.

Listening to an iPod/iPhone Device

When The Bridge IIIP is connected to its proprietary input on the AVR, and an iPod or iPhone is docked, you may play the audio materials on your iPod or iPhone through your high-quality audio/video system, operate the iPod or iPhone using the AVR remote or the AVR's front-panel controls, view navigation messages on the AVR's front panel or a connected video display, and charge the iPod or iPhone.

As of this writing, your AVR supports audio playback from the following Apple products: iPod classic, iPod nano 3G, iPod nano 4G, iPod nano 5G, iPod nano 6G, iPod touch, iPod touch 2G, iPod touch 3G, iPod touch 4G, iPhone, iPhone 3G, iPhone 3GS, iPhone 4G. For the latest compatibility information, please see our Web site: www.harmankardon.com.

After docking an iPod or iPhone device in The Bridge IIIP, select the Bridge Source Selector button on the remote. "Bridge" will appear on the front-panel Message display, and a The Bridge screen will appear on a TV connected to the AVR.

```
SONG: Previously Disenchanted
ARTIST: Jugalbandi
ALBUM: Yellow Star Mailings List
10:17 ▶ 15:33
```

The screen will show the currently playing song, artist, album, elapsed time, play mode and total track time. Use the remote's Transport Control buttons to control playback.

Navigating iPod/iPhone Device Menus

Pressing the remote's Speaker Setup (Menu) button while an iPod/iPhone device is playing in The Bridge IIIP will display the iPod/iPhone Menu screen on a connected TV:

```
Menu
Playlists
▶ Artists
Albums
Songs
Podcasts
Genres
Composers
Audiobooks
```

Use the Up/Down and OK buttons to navigate through the list and select the desired category. When the category's screen appears, use the Up/Down and OK buttons to navigate within the category and make selections. NOTE: Not all categories may appear with all iPod/iPhone devices.

- To return to a previous menu screen at any time, press the Speaker Setup (Menu) button.

Selecting a Surround Mode

Selecting a surround mode can be as simple or sophisticated as your individual system and tastes. Feel free to experiment, and you may find a few favorites for certain sources or program types. You can find more detailed information on surround modes in *Audio Processing and Surround Sound*, on this page.

To select a surround mode, press the OSD Button on the remote to display the Master menu:

```

** MASTER MENU **

  INPUT SETUP
  ► SURROUND MODE
    EzSet/EQ
    MANUAL SETUP
    SYSTEM SETUP
    
```

Use the Up/Down and OK buttons to select Surround Mode. The Surround Mode menu will appear:

```

* MODE : MUSIC *

DOLBY PLII MUSIC

  ► CENTER WIDTH : 3
    DIMENSION    : 0
    PANORAMA     : Off

BACK TO MASTER MENU
    
```

Use the Up/Down and OK buttons to select the desired surround-mode category.

Auto Select: For a digital program, such as a movie recorded with a Dolby Digital or DTS soundtrack, the AVR will automatically use the soundtrack's native surround format. For 2-channel analog and PCM programs, the AVR uses the Logic 7 Movie, Logic 7 Music or Logic 7 Game mode, depending on the source.

Virtual Surround: When only two main speakers are present in the system, you can use HARMAN virtual surround to create an enhanced sound field that virtualizes the missing speakers.

Stereo: When you want 2-channel playback, select the number of speakers you want to use for playback:

- "2 CH Stereo" uses two speakers.
- "5 CH Stereo" plays the left-channel signal through the front left and surround left speakers, the right-channel signal through the front right and surround right speakers, and a summed mono signal through the center speaker.

Movie: Select from the following when you want a surround mode for movie playback: Logic 7 Movie or Dolby Pro Logic II Movie.

Music: Select from the following when you want a surround mode for music playback: Logic 7 Music or Dolby Pro Logic II Music. The Dolby Pro Logic II Music mode provides some additional settings. See *Audio Processing and Surround Sound*, on this page, for more information.

Video Game: Select from the following when you want a surround mode for game playback: Logic 7 Game or Dolby Pro Logic II Game.

After you select the surround-mode category, the Mode menu will appear:

```

* MODE : MUSIC *

DOLBY PLII MUSIC

  ► CENTER WIDTH : 3
    DIMENSION    : 0
    PANORAMA     : Off

BACK TO MASTER MENU
    
```

Use the Left/Right buttons to change the surround mode.

You can also select surround modes using the AVR's front-panel buttons:

1. Press the Surr Mode button. The Message display will show the surround-mode category and surround mode.
2. To change the surround mode within the surround-mode category, press the Surround Select Up/Down buttons. Each press will change to the next surround mode.
3. To change the surround-mode category, press the Surr Mode button. Each press will change to the next surround-mode category.

Advanced Functions

Much of the adjusting and configuration your AVR requires is handled automatically, with little intervention required on your part. You can also customize your AVR to suit your system and your tastes. In this section, we will describe some of the more advanced adjustments available to you.

Audio Processing and Surround Sound

Audio signals can be encoded in a variety of formats that can affect not only the quality of the sound but also the number of speaker channels and the surround mode. You may also manually select a different surround mode, when available.

Analog Audio Signals

Analog audio signals usually consist of two channels – left and right. Your AVR offers two options for analog playback:

DSP Surround Off Mode: The DSP Surround Off mode digitizes the incoming signal and applies the bass-management settings, including speaker configuration, delay times and output levels. Select this mode when your front speakers are small, limited-range satellites and you are using a subwoofer. To select this mode, use a digital audio input or turn the Tone Control setting off, then select 2 CH Stereo mode.

Analog Surround Modes: Your AVR is able to process 2-channel audio signals to produce multichannel surround sound, even when no surround sound has been encoded in the recording. Among the available modes are the Dolby Pro Logic II, HARMAN virtual speaker, Logic 7 and 5 CH Stereo modes. To select one of these modes, see *Selecting a Surround Mode*, on this page.

Digital Audio Signals

Digital audio signals offer greater flexibility and capacity than analog signals and allow the encoding of discrete channel information directly into the signal. The result is improved sound quality and startling directionality, since each channel's information is transmitted discretely. High-resolution recordings sound extraordinarily distortion-free, especially in the high frequencies.

Surround Modes

Surround-mode selection depends upon the format of the incoming audio signal as well as your personal taste. Although there is never a time when all of the AVR's surround modes are available, there is usually a wide variety of modes available for a given input. Table A9 in the Appendix, on page 31, offers a brief description of each mode and indicates the types of incoming signals or digital bitstreams the mode may be used with. Additional information about the Dolby and DTS modes is available on the companies' Web sites: www.dolby.com and www.dtsonline.com.

When in doubt, check the jacket of your disc for more information on which surround modes are available. Usually, nonessential sections of the disc, such as trailers, extra materials or the disc menu, are available only in Dolby Digital 2.0 (2-channel) or PCM 2-channel mode. If the main title is playing and the display shows one of these surround modes, look for an audio or language setup section in the disc's menu. Also, make sure your disc player's audio output is set to the original bitstream rather than 2-channel PCM. Stop play and check the player's output setting.

The channels included in a typical 5.1-channel recording are front left, front right, center, surround left, surround right and LFE (low-frequency effects). The LFE channel is denoted as ".1" to represent the fact that it is limited to the low frequencies.

Digital formats include Dolby Digital 2.0 (two channels only), Dolby Digital 5.1, Dolby Digital EX (6.1), Dolby Digital Plus (7.1), Dolby TrueHD (7.1), DTS-HD High-Resolution

Audio (7.1), DTS-HD Master Audio (7.1), DTS 5.1, DTS 96/24 (5.1), 2-channel PCM modes in 32kHz, 44.1kHz, 48kHz or 96kHz, and 5.1 or 7.1 multichannel PCM. (Your AVR will downmix the discrete surround back-channel information in 6.1-channel and 7.1-channel recordings into your system's surround left and surround right channels.)

When the AVR receives a digital bitstream, it detects the encoding method and the number of channels, which is displayed briefly as three numbers, separated by slashes (e.g., "3/2/1").

The first number indicates the number of front channels in the signal: "1" represents a monophonic recording (usually an older program that has been digitally remastered or, more rarely, a modern program for which the director has chosen mono as a special effect). "2" indicates the presence of the left and right channels but no center channel. "3" indicates that all three front channels (left, right and center) are present.

The second number indicates whether any surround channels are present: "0" indicates that no surround information is present. "1" indicates that a matrixed surround signal is present. "2" indicates discrete surround left and right channels. (Bitstreams with discrete surround back left and right channel signals will be indicated by a "4," although the AVR downmixes the surround back-channel information into the surround left and right channels.)

The third number is used for the LFE channel: "0" indicates no LFE channel. "1" indicates that an LFE channel is present.

Dolby Digital 2.0 signals may include a Dolby Surround flag indicating DS-ON or DS-OFF, depending on whether the 2-channel bitstream contains only stereo information or a downmix of a multichannel program that can be decoded by the AVR's Dolby Pro Logic decoder. By default, these signals are played in Dolby Pro Logic II Movie mode.

When a PCM signal is received, the PCM message and the sampling rate (32kHz, 44.1kHz, 48kHz or 96kHz) will appear.

When only two channels – left and right – are present, the analog surround modes may be used to decode the signal into multiple channels. If you would prefer a different surround format than the native signal's digital encoding, press the Surround Modes button to display the Surround Modes menu (see *Selecting a Surround Mode*, on page 20).

The Auto Select option sets the surround mode to the native signal's digital encoding, e.g., Dolby Digital, DTS, Dolby TrueHD or DTS-HD Master Audio. For analog 2-channel materials, the AVR defaults to the Logic 7 Movie mode. For Dolby Digital 2.0 programs, the AVR defaults to the Dolby Pro Logic II Movie mode, which creates a 5.1-channel surround-sound presentation from the 2-channel program. If you prefer a different surround mode, select the surround-mode category: Virtual Surround, Stereo, Movie, Music or Video Game. Press the OK button to change the mode.

Each surround-mode category is set to a default surround mode:

- Virtual Surround: HARMAN virtual speaker.
- Stereo: 5-CH Stereo.
- Movie: Logic 7 Movie.
- Music: Logic 7 Music.
- Video Game: Logic 7 Game.

You may select a different mode for each category. Below is a complete list of available surround modes. (The actual surround modes available will depend on the number of speakers in your system.)

- Virtual Surround: HARMAN virtual speaker.
- Stereo: 2-CH Stereo or 5-CH Stereo.
- Movie: Logic 7 Movie, Dolby Pro Logic II Movie.
- Music: Logic 7 Music, Dolby Pro Logic II Music.
- Video Game: Logic 7 Game, Dolby Pro Logic II Game.

Once you have programmed the surround mode for each type of audio, select the line from the Surround Modes menu to override the AVR's automatic surround-mode selection. The AVR will use the same surround mode the next time the source is selected.

Please refer to Table A9 in the Appendix for more information on which surround modes are available with different bitstreams.

Dolby Pro Logic II Music Mode Adjustments

When you select Dolby Pro Logic II as the music surround mode, additional adjustments become available:

```
* MODE : MUSIC *
DOLBY PLII MUSIC
▶ CENTER WIDTH : 3
  DIMENSION   : 0
  PANORAMA    : Off
BACK TO MASTER MENU
```

Center Width: This setting affects how vocals sound through the three front speakers. A lower number focuses the vocal information tightly on the center channel. Higher numbers (up to 7) broaden the vocal soundstage. Use the Left/Right buttons to adjust this setting.

Dimension: This setting affects the depth of the surround presentation, allowing you to "move" the sound toward the front or rear of the room. The setting of "0" is a neutral default. Setting "F-3" moves the sound toward the front of the room, while setting "R-3" moves the sound toward the rear. Use the Left/Right buttons to adjust it.

Panorama: With the Panorama mode turned on, some of the sound from the front speakers is moved to the surround speakers, creating an enveloping "wraparound" effect. Each press of the OK button toggles the setting On or Off.

Manual Speaker Setup

Your AVR is flexible and may be configured to work with most speakers and to compensate for the acoustic characteristics of your room.

The EzSet/EQ process automatically detects the capabilities of each connected speaker and optimizes the AVR's performance with your speakers. If you are unable to run EzSet/EQ calibration, or if you wish to set up your AVR for your speakers manually, use the Manual Speaker Setup on-screen menus.

Before beginning, place your loudspeakers as explained in the *Place Your Speakers* section, on page 10, and connect them to the AVR. Consult the owner's guide for the speakers or the manufacturer's Web site for their frequency-range specification. Although you may set the AVR's individual channel levels "by ear," an SPL (sound-pressure level) meter purchased at a local electronics store will provide greater accuracy.

Record your configuration settings in Tables A4 and A6 in the Appendix for easy re-entry after a system reset or after the AVR's Master Power switch has been turned off or the unit has been unplugged for more than four weeks.

Step One – Determine Your Speakers' Crossover Frequencies

Without using the EzSet/EQ process, the AVR can't detect how many speakers you've connected to it; nor can it determine their capabilities. Consult the technical specifications for all of your speakers and locate the frequency response, usually given as a range, e.g., 100Hz – 20kHz (±3dB). Write down the lowest frequency that each of your speakers is capable of playing (100Hz in the above example) as the crossover in Table A6 in the Appendix. NOTE: This frequency is *not* the same as the crossover frequency listed in the speaker's specifications.

For the subwoofer, write down the transducer size. The AVR's bass management determines which speakers will be used to play back the low-frequency (bass) portion of the source program. Sending the lowest notes to small satellite speakers will result in bad sound and may even damage the speakers. The highest notes may not be heard at all through the subwoofer.

With proper bass management, the AVR divides the source signal at a crossover point. All information above that crossover point is played through your system's speakers, and all information below the crossover point is played through the subwoofer. This way, each loudspeaker in your system will perform at its best, delivering a more powerful and enjoyable sound experience.

Step Two – Measure the Speaker Distances

Ideally, all of your speakers would be placed in a circle, with the listening position at the center. However, you may have had to place some speakers a little farther away from the listening position than others. Sounds that are supposed to arrive simultaneously from different speakers may blur, due to different arrival times.

Your AVR provides a Distance adjustment that compensates for these real-world speaker-placement differences.

Measure the distance from each speaker to the listening position, and write it down in Table A4 in the Appendix. Even if all of your speakers are the same distance from the listening position, enter your speaker distances as described in *Set the Speaker Distances*, on this page.

Step Three – Manual Setup Menu

Now you are ready to program the AVR. Sit in your usual listening position, and make the room as quiet as possible.

With the AVR and video display turned on, press the OSD button to display the menu system and select Manual Setup. The Manual Setup menu will appear:

```

* MANUAL SETUP *
▶ NUMBER OF SPEAKERS
  SUB MODE : SUB
  CROSSOVER
  DISTANCE
  LEVEL ADJUST
  BACK TO MASTER MENU
    
```

NOTE: All of the speaker setup submenus include a “Back to...” option. To save the current settings, select the Back to... option.

For best results, adjust the submenu in this order: Number of Speakers, Crossover, Sub Mode, Distance and Level Adjust.

Number of Speakers

This selection lets you program the correct setting for each speaker group. The settings in this menu affect the remainder of the speaker-setup process and the availability of various surround modes at any time.

Select ON when the speakers are present in the system; select OFF for positions where no speakers are installed. The Front Left & Right setting is always ON and may not be disabled.

```

* NUMBER OF SPEAKERS *
▶ LEFT/RIGHT : ON
  CENTER : ON
  SURROUND : ON
  SUBWOOFER : ON
  BACK TO MANUAL SETUP
    
```

When you have finished, select Back to Manual Setup.

Crossover (Size)

After you return to the Manual Setup menu, navigate to the Crossover line and press the OK button to display the Crossover menu.

```

* CROSSOVER *
▶ LEFT/RIGHT : 100Hz
  CENTER : 100Hz
  SURROUND : 100Hz
  SUBWOOFER : 10inch
  BACK TO MANUAL SETUP
    
```

Refer to Table A6 for each speaker's crossover frequency.

NOTE: The AVR will let you adjust settings only for those speaker groups you set to On in the Number of Speakers menu.

For each speaker group, select one of these eight crossover frequencies: LARGE, 40Hz, 60Hz, 80Hz, 100Hz, 120Hz, 150Hz or 200Hz. If the speaker's crossover frequency is below 40Hz, select the first option, LARGE. This setting doesn't refer to the speaker's physical size but to its frequency response, which is also called “full range.”

Specify the size of the subwoofer's transducer as 8, 10, 12 or 15 inches. The AVR always sets the subwoofer crossover to 100Hz but uses the transducer size for equalization.

Write down the settings in Table A6 in the Appendix.

When you have finished entering the settings, select Back To Manual Setup.

Sub Mode

After you return to the Manual Setup menu, navigate to the Sub Mode line and press the OK button to display the Sub Mode menu. This setting depends upon the Crossover setting you selected for the front left and right speakers.

- If you set the front speakers to a numeric crossover frequency, the subwoofer setting will always be SUB. All low-frequency information will always be sent to the subwoofer. If you don't have a subwoofer, either upgrade to full-range front left and right speakers or add a subwoofer at the earliest opportunity.
- If you set the front speakers to LARGE, select one of the three following settings for the subwoofer:

L/R+LFE: This setting sends all low-frequency information to the subwoofer, including a) information that would normally be played through the front left and right speakers and b) the special low-frequency effects (LFE) channel information.

OFF: Select this setting when no subwoofer is in use. All low-frequency information will be sent to the front left and right speakers.

LFE: This setting plays low-frequency information contained in the left and right program channels through the front left and right speakers, and directs only the LFE-channel information to the subwoofer.

When you have finished entering the settings, select Back To Manual Setup.

Set the Speaker Distances

As described above in Step Two, when you measured the distances from each of your speakers to the listening position, your AVR provides an adjustment that compensates for the different distances so that the sound from each speaker will reach the listening position at the proper time. This process will improve the clarity and detail of the sound.

After you return to the Manual Setup menu, navigate to the Distance line and press the OK button to display the Distance menu.

```

* DISTANCE *
▶ FL : 10FT    SL : 10FT
  CEN : 10FT  SUB : 10FT
  FR : 10FT
  SR : 10FT

  DELAY RESET : OFF
  UNIT : FEET
  A/V SYNC DELAY : 0ms
  BACK TO MANUAL SETUP
    
```

Enter the distance from each speaker to the listening position that you measured in Step Two and recorded in Table A4 in the Appendix (see page 28). Select a speaker, then use the Left/Right buttons to change the measurement. You can enter distances between 0 and 30 feet (9.1m). The default distance for all speakers is 10 feet (3m).

The default unit of measurement is feet. To change the unit to meters, scroll down to the Unit line and press the Left/Right buttons.

When you have finished entering the settings, select Back To Manual Setup.

Step Four – Setting Channel Output Levels Manually

For a conventional stereo AVR, a simple balance control adjusts the stereo imaging by varying the relative loudness of the left and right channels. In a home theater system with up to seven main channels plus a subwoofer, achieving proper imaging becomes both more critical and more complex. The goal is to ensure that each channel is heard at the listening position with equal loudness (when signals of equal loudness are played through them).

Your AVR's EzSet/EQ calibration can handle this critical task for you simply and automatically. However, the AVR's Adjust Speaker Levels menu allows you to calibrate the levels manually, either using the system's built-in test tone or while playing source material.

After you return to the Manual Setup menu, navigate to the Level Adjust line and press the OK button to display the Level Adjust menu.

```

* LEVEL ADJUST*
▶ FL : 0dB      SL : 0dB
  CEN: 0dB     SUB: 0dB
  FR  : 0dB
  SR  : 0dB

CHANNEL RESET: OFF
TEST TONE SEQ: MANUAL
TEST TONE     : OFF

BACK TO MANUAL SETUP

```

All of the system's speakers will appear with their current level settings. You can adjust each speaker's level between -10dB and +10dB in 1dB increments.

While making adjustments, you can measure the channel levels in one of these ways:

- Preferably, use a handheld SPL meter set to the C-weighting, slow scale. Adjust each speaker so that the meter reads 75dB when the AVR's built-in test noise is playing.
- By ear. Adjust the levels so that the test tone sounds equally loud to you when it plays through each speaker.

To set your levels using the AVR's internal test tone, select the menu's Test Tone Seq line and use the Left/Right buttons to select between Auto and Manual. After selecting Auto or Manual, move the cursor to the Test Tone line and use the Left/Right buttons to change the setting to On.

Auto: The test tone will automatically circulate to all speakers, as indicated by the highlight bar. Use the Left/Right buttons to adjust the level for any speaker when the test tone is paused there. Use the Up/Down buttons to move the cursor to another line, and the test tone will follow the cursor. To stop the test tone, use the Up/Down buttons to move the cursor out of the screen's speaker-listings area.

Manual: The test tone will stay on the current speaker until you use the Up/Down buttons to move it to another speaker. Use the Left/Right buttons to adjust the level for the speaker through which the test tone is playing.

If you are using an external source to set your output levels, set Test Tone to Off, use the Up/Down buttons to navigate to each speaker, and use the Left/Right buttons to adjust the speaker's level while the source plays. **NOTE:** If you are using a handheld SPL meter with external source material, such as a test disc or an audio selection, play it and adjust the AVR's master volume control until the meter measures 75dB. Then adjust the individual speaker levels.

Channel Reset: To reset all channel levels to their factory defaults of 0dB, select this line and press the Left/Right buttons.

When you have finished adjusting the speaker levels, record the settings in Table A6 in the Appendix. Then select the Back to Manual Setup option in the OSD.

Notes on Setting Speaker Volumes in Home Theater Systems:

While setting your system's individual speaker volume levels is ultimately up to your personal taste, here are some ideas you may find helpful:

- For films and video-music programs, your overall goal should be to create an enveloping, realistic sound field that draws you into the film or music program without drawing your attention away from the action on the screen.

- For multichannel music recordings, some music producers will create a sound field that places the musicians all around you; others will create a sound field that places the musicians in front of you, with more subtle ambience in the surround speakers (as you would experience in a concert hall).

- In most 5.1-channel film soundtracks, the surround speakers are not intended to be as loud or as active as the front speakers. Adjusting the surround speakers so they are always as loud as the front speakers could make dialogue difficult to understand and will make some sound effects sound unrealistically loud.

Notes on Setting Subwoofer Volume:

- Sometimes the ideal subwoofer volume setting for music is too loud for films, while the ideal setting for films is too quiet for music. When setting the subwoofer volume, listen to both music and films with strong bass content and find a "middle ground" volume level that works for both.

- If your subwoofer always seems too loud or too quiet, you may want to place it in a different location. Placing the subwoofer in a corner will always tend to increase its bass output, while placing it away from any walls or corners will always tend to lessen its bass output.

System Setup

The AVR's System Setup menu lets you customize in what way many of the AVR's features operate. Press the OSD button and navigate to the System Setup line. Press the OK button to display the System Setup menu.

VFD Fade Time Out: Some people find the brightness of the AVR's front-panel display distracting during movies or listening sessions. It's possible to dim the front-panel display completely using the remote's Display Dimmer button (see *System Remote Control Functions*, on pages 8 and 9). The VFD Fade Time Out sets the display to remain dark most of the time, lighting up only when a button is pressed or a remote command is received, and going dark again five seconds after the last command. The feature also causes the display to light up only when a button is pressed but the display immediately begins to fade to dark. This setting allows you to program the length of the fade time. Select a time-out period of between three and ten seconds, or select Off if you prefer to leave the displays on at all times or to use the Display Dimmer button.

Volume Default and Default Volume Set: These two settings are used together to program the volume level when you turn on the AVR. Set Volume Default to On, and then set the Default Volume Set to the desired turn-on volume. When Volume Default is set to Off, the AVR will turn on at the last-used volume setting from the previous listening session.

HDMI Audio To TV: This setting determines whether HDMI audio signals are passed through the HDMI Monitor Out connector to the video display. In normal operation, leave this setting at Off, as audio will be played through the AVR. To use the TV by itself, without the home theater system, turn this setting to On. In this case, you will need to mute the TV's speakers (or switch the setting to Off) when using the AVR for audio.

Semi OSD Time Out: Program the amount of time (2 to 5 seconds) the two-line semi-OSD status messages remain on screen, or deactivate the semi-OSD display altogether if you find it distracting. These messages will continue to appear on the front panel of the AVR.

Full OSD Time Out: Program the amount of time (20, 30, 40 or 50 seconds) the full OSD menus remain visible on screen. The full OSD system may not be deactivated. **NOTE:** It isn't possible to view video sources while the full OSD menus are displayed.

HDMI Link: This setting allows the communication of control information among the HDMI devices in your system. Turn this setting to On to allow control communication among the HDMI devices; turn the setting to Off to forbid control communication.

HDMI ARC: Selecting On will send audio from the TV to the AVR via the HDMI Audio Return Channel (ARC) connection (which is in the HDMI cable connecting the AVR to the TV). This way, whenever you're watching a source that is connected directly to your TV (such as an Internet connection), you can listen to the sound through the AVR. **NOTE:** This setting is available only when HDMI Link is set to On.

Advanced Remote Control Programming

Remote Channel-Control Punch-Through

The punch-through feature allows you to operate one component while setting certain groups of controls to operate another component. For example, while using the AVR controls for surround modes and other audio functions, you may also use the remote to operate the transport controls of your Blu-ray Disc player. Or while using the remote to control video functions on your TV, you may also use the remote to change channels on your cable box.

To program punch-through control while operating any device:

- For three seconds, press and hold the Source Selector button (or the AVR button) for the main device the remote will be operating. The Program Indicator LED will flash, indicating that the remote is in Program mode and that you may release the button.
- Select the type of punch-through programming.
 - To program volume-control punch-through, press the Volume Up button.
 - To program channel-control punch-through, press the Volume Down button.
 - To program transport-control punch-through, press the Play transport-control button.
- Press the Source Selector button for the device whose volume, channel or transport-controls you will use while operating the device selected in the first step. The Program Indicator LED will flash to confirm.

To undo punch-through programming, follow the same steps as above, but press the same Source Selector button in Steps 1 and 3.

You may reassign the transport-control punch-through programming for the AVR, VID2 and VID3 devices to another device, such as a CD player. If you wish to remove transport-control punch-through altogether for the AVR, VID2 or VID3 device, follow the same procedure as for programming punch-through, but in Step 3 press either of the other two of these three special selector buttons. For example, to remove transport-control punch-through from the VID3 device so that pressing any of the transport controls will have no effect, press and hold the VID3 Button until the Program Indicator LED flashes, then press the Play Button, followed by either the AVR or VID2 Button.

Programming Macro Commands

Each of the AVR remote's four Macro buttons and the Power On button (see *System Remote Control Functions*, on pages 8 and 9) can be programmed to send out up to 19 commands at one time from a single button push. Any AVR remote control button's function from any mode (except the Mute button, the Dim button and the Channel Up/Down buttons) can be programmed into a macro.

NOTE: Use caution when programming complicated macros. It isn't possible to program a pause or delay before sending additional commands after a "Power On" command, and the component may not be ready to respond to commands immediately after powering on.

To program a macro:

- Simultaneously press one of the four Macro buttons, or the Power On button, and the Mute button to enter the Programming mode.
- Press in up to 19 commands that you want stored in that Macro button. Press the Source Selector button for each device (or AVR button for the AVR itself) before you enter individual commands. This step counts as one of the 19 commands allowed for each Macro.
- For the Power On command, DO NOT press the Power On button. Press the Mute button instead.
- Press the Power Off button to program the Power Off command.
- Press the Sleep button to end the programming process.

It isn't possible to "edit" a command within a macro. However, you may erase the macro as follows:

- Simultaneously press and hold the Mute button and the Macro button containing the macro until the Program Indicator LED flashes.
- Press the Channel Down button to erase the macro.

To execute a macro, press the Macro button (or the Power On button) into which you programmed the macro.

Recording

Two-channel analog and digital audio signals, as well as composite video signals, are normally available at the appropriate recording output connectors. To make a recording, connect your audio or video recorder to the appropriate AVR output connectors as described in the *Making Connections* section, insert blank media in the recorder and make sure the recorder is turned on and recording while the source is playing. Refer to the recording device's instructions for complete information about making recordings.

NOTES:

- The AVR does not convert analog signals to digital or vice versa.
- Only PCM digital audio signals are available for recording. Proprietary formats such as the Dolby Digital and DTS bitstreams may not be recorded using the digital audio connections. Use the analog audio connections to make an analog recording.
- HDMI and component video sources are not available for recording.
- Please make certain that you are aware of any copyright restrictions on any material you record. Unauthorized duplication of copyrighted materials is prohibited by law.

Sleep Timer

The sleep timer sets the AVR to play for up to 90 minutes and then turn off automatically.

Press the Sleep button on the remote, and the time until turn-off will be displayed on the front-panel Message display and on a connected TV. Each additional press of the Sleep button decreases the play time by 10 minutes, with a maximum of 90 minutes. The SLEEP OFF setting disables the sleep timer.

When the sleep timer has been set, the front-panel display will automatically dim to half brightness.

If you press the Sleep button after the timer has been set, the remaining play time will be displayed. Press the Sleep button again to change the play time.

Resetting the Remote

To reset the remote to its factory-default condition, simultaneously press and hold any Source Selector button and the "0" Number button. When the Program Indicator LED flashes amber, enter the code "333." When the green LED goes out, the remote control will be reset.

Processor Reset

If the AVR behaves erratically after a power surge, first turn off the rear-panel Main Power switch and unplug the AC power cord for at least 3 minutes. Plug the cord back in and turn the AVR on. If this procedure doesn't help, reset the AVR's processor as described below.

NOTE: A processor reset erases all user configurations, including video resolution, speaker and level settings, and tuner presets. After a reset, reenter all of these settings from your notes in the Appendix worksheets.

To reset the AVR's processor:

- Press the front-panel Standby/On switch to place the unit in the Standby mode (the Power Indicator LED will turn amber).
- Press and hold the front-panel Surround Mode button for at least 5 seconds until the RESET message appears on the front-panel Message display.

If the AVR does not function correctly after a processor reset, contact an authorized Harman Kardon service center for assistance. Authorized service centers may be located by visiting our Web site at www.harmankardon.com.

Memory

If the AVR is unplugged or experiences a power outage, it will retain your user settings for up to four weeks.

Troubleshooting

Symptom	Cause	Solution
Unit does not function when Main Power switch is turned on	<ul style="list-style-type: none"> No AC power 	<ul style="list-style-type: none"> Ensure that the power cord is plugged into a live AC power outlet Check if the AC outlet is switch-controlled
Front-panel Message display lights, but there's no sound or picture	<ul style="list-style-type: none"> Intermittent input connection Mute is on Volume control is turned down 	<ul style="list-style-type: none"> Secure all input and speaker connections Press Mute button Turn up Volume control
No sound from any speaker; PROTECT message appears on Message display	<ul style="list-style-type: none"> Amplifier is in protection mode due to possible short circuit Amplifier is in protection mode due to internal problems 	<ul style="list-style-type: none"> Check all speaker wires at speaker and AVR connections for crossed wires Contact your local Harman Kardon service center
No sound from center or surround speakers	<ul style="list-style-type: none"> Incorrect surround mode Program material is monophonic Incorrect speaker configuration Program material is stereo 	<ul style="list-style-type: none"> Select a surround mode other than stereo Mono programs contain no surround information Check the speaker configuration in the setup menu The surround decoder may not create center- or surround-channel information from nonencoded stereo programs
Unit does not respond to remote control commands	<ul style="list-style-type: none"> Weak batteries in remote AVR not selected Remote sensor is obscured 	<ul style="list-style-type: none"> Change batteries in remote Press the Setup/AVR button Ensure that the AVR's front-panel remote sensor is in the line of sight of the remote
Intermittent buzzing in tuner	<ul style="list-style-type: none"> Local interference 	<ul style="list-style-type: none"> Move the AVR or antenna away from computers, fluorescent lights, motors or other electrical appliances
Unable to activate remote control Programming mode	<ul style="list-style-type: none"> Source Selector button is not held for at least 3 seconds 	<ul style="list-style-type: none"> Be sure to hold the Source Selector button for at least 3 seconds

Additional information on troubleshooting possible problems with your AVR and installation-related issues may be found in the list of "Frequently Asked Questions," which is located in the Product Support section of our Web site: www.harmankardon.com

Specifications

Audio Section

Stereo power:	95W per channel, two channels driven @ 8 ohms, 20Hz – 20kHz, <0,07% THD
Multichannel power:	95W per channel, two channels driven @ 8 ohms, 20Hz – 20kHz, <0,07% THD
Input sensitivity/impedance:	200mV/47k ohms
Signal-to-noise ratio (IHF-A):	100dB
Surround system adjacent-channel separation:	Dolby Pro Logic/PLII: 40dB Dolby Digital: 55dB DTS: 55dB
Frequency response:	10Hz – 130kHz (+0dB/-3dB)
High instantaneous-current capability (HCC):	±25 amps
Transient intermodulation distortion (TIM):	Unmeasurable
Slew rate:	40V/μsec

FM Tuner Section

Frequency range:	87.5 – 108.0MHz
Usable sensitivity IHF:	1.3μV/13.2dBf
Signal-to-noise ratio (mono/stereo):	70dB/68dB
Distortion (mono/stereo):	0.2%/0.3%
Stereo separation:	40dB @ 1kHz
Selectivity (±400kHz):	70dB
Image rejection:	80dB
IF rejection:	90dB

AM Tuner Section

Frequency range:	520 – 1720kHz
Signal-to-noise ratio:	45dB
Usable sensitivity (loop):	500μV
Distortion (1kHz, 50% mod):	0.8%
Selectivity (±10kHz):	30dB

Video Section

Television format:	NTSC (AVR 1650); PAL (AVR 165)
Input level/impedance:	1Vp-p/75 ohms
Output level/impedance:	1Vp-p/75 ohms
Video frequency response (composite video):	10Hz – 8MHz (-3dB)
HDMI:	Version 1.4a with 12-bit Deep Color

General Specifications

Power requirement:	120V AC/60Hz (AVR 1650); 220V – 240V AC/50Hz – 60Hz (AVR 165)
Power consumption:	<0.5W (standby); 280W maximum
Dimensions (W x H x D)	17-5/16" x 6-1/2" x 17-1/8" (440mm x 165mm x 435mm)
Weight	20 lb (9.1kg)

Appendix – Default settings, worksheets, remote product codes

Table A1 – Recommended Source Component Connections

Device Type	AVR Source	Audio Connections	Video Connections
Cable TV, Satellite, HDTV or other device that delivers television programs	Video 1	<ul style="list-style-type: none"> • Video 1 Analog inputs • Optical 1 Input (if not in use with HDMI 3) 	Composite Video 1 Input
VCR, DVR, PVR, or other audio/video recorder	Video 2	<ul style="list-style-type: none"> • Video 2 Analog (inputs and outputs) • Any one available coaxial or optical digital audio input with corresponding coax digital output 	<ul style="list-style-type: none"> • Composite Video 2 Input • For recording, use Composite Video 2 Output
DVD player, Blu-ray Disc player	DVD or HDMI (for Blu-ray Disc)	<ul style="list-style-type: none"> • DVD Analog Inputs • Coax 1 Input 	• DVD Component Video Input
HDMI-capable disc player, game console or other audio/video device	HDMI 1	• HDMI 1 Input	• HDMI 1 Input
HDMI-capable disc player, game console or other audio/video device	HDMI 2	• HDMI 2 Input	• HDMI 2 Input
HDMI-capable disc player, game console or other audio/video device	HDMI 3	• HDMI 3 Input	• HDMI 3 Input
HDMI-capable disc player, game console or other audio/video device	HDMI 4	• HDMI 4 Input	• HDMI 4 Input
Portable audio device	AUX	• AUX Input on front panel	• Not required
CD player	CD	<ul style="list-style-type: none"> • CD Analog Inputs • Any one available coaxial or optical digital audio input 	• Not required
CD-R, MiniDisc, cassette	Tape	<ul style="list-style-type: none"> • Tape Analog (inputs and outputs) • Any one available coaxial or optical digital audio input • Use corresponding optical digital output 	• Not required
iPod or iPhone	Bridge	• The Bridge IIP	• Not required

Note: The AVR is equipped with a total of three digital audio inputs. Certain digital audio connections are recommended simply because those digital audio inputs are assigned to those sources by default at the factory. But any digital audio input may be reassigned to any source. Since you may not be using all of the AVR's sources, you may reassign a digital audio input that is recommended for a source you aren't using to another device. Table A1 is a guideline; you may need to make adjustments to fit your system.

Table A2 – Source Setting Defaults

Source	DVD	HDMI 1	HDMI 2	HDMI 3	HDMI 4	Video 1	Video 2	Bridge	Aux	CD	Tape	Tuner	TV
Title								BRIDGE				TUNER	
Audio Input	COAX 1	HDMI	HDMI	HDMI	HDMI	ANALOG	OPTICAL 1	THE BRIDGE IIP	ANALOG	ANALOG	ANALOG	INT. TUNER	OPTICAL 1
Auto Poll	ON	OFF	OFF	OFF	OFF	OFF	ON	--	OFF	OFF	ON	--	OFF
Surround Mode	LOGIC 7 MOVIE	LOGIC 7 MOVIE	LOGIC 7 MOVIE	LOGIC 7 MOVIE	LOGIC 7 MOVIE	LOGIC 7 MOVIE	LOGIC 7 MOVIE	LOGIC 7 MOVIE	LOGIC 7 MOVIE	LOGIC 7 MOVIE	LOGIC 7 MOVIE	LOGIC 7 MOVIE	LOGIC 7 MOVIE

Table A3 – Speaker/Channel Setting Defaults

Source	All Sources
Left/Right Speaker	ON
Center Speaker	ON
Surround Speaker	ON
Surround Back Speaker	ON
Subwoofer	ON
Left/Right Speaker Crossover	100Hz
Center Speaker Crossover	100Hz
Surround Speaker Crossover	100Hz
Surround Back Speaker Crossover	100Hz
LFE	PRESENT
Sub Mode	SUB

Table A4 – Distance Settings

Speaker Positions	Your Distances From Speaker to Listening Position
Front Left	
Center	
Front Right	
Surround Right	
Surround Left	
Subwoofer	
AV Sync Delay	0mS

Table A5 – Source Settings

Source	DVD	HDMI 1	HDMI 2	HDMI 3	HDMI 4	Video 1	Video 2	The Bridge	Aux	CD	Tape	Tuner
Title												INT. TUNER
Video Input												
Component Video Input		N/A	N/A	N/A	N/A	N/A	N/A	N/A	N/A	N/A	N/A	N/A
Digital Audio Input								N/A	N/A			N/A
Analog Audio Input	DVD					VIDEO 1	VIDEO 2	THE BRIDGE III P	AUX (FRONT-PANEL)	CD	TAPE	TUNER
Auto Poll								OFF	N/A			N/A

Table A6 – Speaker/Channel Settings

	Front Left	Front Right	Center	Surround Left	Surround Right	Subwoofer
Number of Speakers	ON					
Crossover						
Distance						
Channel Level Adjust						

Table A7 – Remote Control Codes

Source Input	Product Type (circle one)	Remote Control Code
Video 1	VCR, PVR, DMC	
Video 2	Cable, Satellite	
HDMI 1	DVD, Blu-ray Disc player, VCR/PVR/DMC, Cable/Satellite	
HDMI 2	DVD, Blu-ray Disc player, VCR/PVR/DMC, Cable/Satellite	
HDMI 3	DVD, Blu-ray Disc player, VCR/PVR/DMC, Cable/Satellite	
HDMI 4	DVD, Blu-ray Disc player, VCR/PVR/DMC, Cable/Satellite	
DVD	DVD, Blu-ray Disc player, VCR/PVR/DMC, Cable/Satellite	
CD	CD, CD-R	
Tape	Cassette, CD-R	

Table A8 – System Settings

Feature	Default Setting	Your Setting
VFD Fade Time-Out	OFF	
Volume Default	OFF	
Default Vol Set	-25dB	
HDMI Audio to TV	OFF	
Semi-OSD Time-Out	5 Seconds	
Full-OSD Time-Out	20 Seconds	
HDMI Link	OFF	
HDMI ARC	OFF	

Table A9 – Surround Modes

Surround Mode	Description	Incoming Bitstream or Signal
Dolby Digital	Provides up to five separate main audio channels and a dedicated low-frequency effects (LFE) channel.	<ul style="list-style-type: none"> • Dolby Digital 1/0/.0 or .1, 2/0/.0 or .1, 3/0/.0 or .1, 2/1/.0 or .1, 2/2/.0 or .1, 3/2/.0 or .1 • Dolby Digital EX (played as 5.1) • Dolby Digital Plus decoded and delivered via coaxial or optical connection
Dolby Digital Plus	An enhanced version of Dolby Digital encoded more efficiently, Dolby Digital Plus has the capacity for additional discrete channels and for streaming audio from the Internet, all with enhanced audio quality. Source material may be delivered via an HDMI connection or decoded to Dolby Digital or PCM and transmitted via coaxial or optical digital audio.	<ul style="list-style-type: none"> • Dolby Digital Plus via HDMI connection (source device decodes to Dolby Digital when a coaxial or optical connection is used)
Dolby TrueHD	Dolby TrueHD is an expansion of MLP Lossless™ audio, the same format used on DVD-Audio discs. Dolby TrueHD adds the features found in Dolby Digital, such as night mode settings, while delivering fully lossless audio that is a true reproduction of studio master recordings.	<ul style="list-style-type: none"> • Blu-ray Disc or HD-DVD encoded with Dolby TrueHD, delivered via HDMI
Dolby Digital Stereo	Delivers a 2-channel downmix of Dolby Digital materials.	<ul style="list-style-type: none"> • Dolby Digital 1/0/.0 or .1, 2/0/.0 or .1, 3/0/.0 or .1, 2/1/.0 or .1, 2/2/.0 or .1, 3/2/.0 or .1 • Dolby Digital EX
Dolby Pro Logic II Mode Group	Analog decoder that derives five full-range, discrete main audio channels from matrix surround-encoded or 2-channel analog sources. Four variants are available.	See below
Dolby Pro Logic II Movie	Variant of Dolby Pro Logic II that is optimized for movie and television programs.	<ul style="list-style-type: none"> • Dolby Digital 2.0 or 2.1 • Analog (two-channel) • Tuner • PCM (32kHz, 44.1kHz, 48kHz, 96kHz)
Dolby Pro Logic II Music	Variant of Dolby Pro Logic II that is optimized for music selections. Allows adjustment of sound-field presentation in three dimensions: <ul style="list-style-type: none"> • Center Width (adjusts width of vocal soundstage) • Dimension (adjusts depth of soundstage) • Panorama (adjusts wraparound surround effect) 	<ul style="list-style-type: none"> • Dolby Digital 2.0 or 2.1 • Analog (two-channel) • Tuner • PCM (32kHz, 44.1kHz, 48kHz, 96kHz)
Dolby Pro Logic II Game	Variant of Dolby Pro Logic II that emphasizes use of the surround channels and subwoofer for total immersion in the video gaming experience.	<ul style="list-style-type: none"> • Dolby Digital 2.0 or 2.1 • Analog (two-channel) • Tuner • PCM (32kHz, 44.1kHz, 48kHz, 96kHz)
Dolby Pro Logic	Original version of Dolby Pro Logic that steered a mono signal containing information below 7kHz to the surround channels.	<ul style="list-style-type: none"> • Dolby Digital 2.0 or 2.1 • Analog (two-channel) • Tuner • PCM (32kHz, 44.1kHz, 48kHz, 96kHz)
Harman Virtual Speaker	Simulates 5.1 channels when only two speakers are present or a more enveloping sound field is desired.	<ul style="list-style-type: none"> • Dolby Digital • Analog (two-channel) • Tuner • PCM (32kHz, 44.1kHz or 48kHz)

Table A9 – Surround Modes (cont.)

Surround Mode	Description	Incoming Bitstream or Signal
DTS Digital	Using a different encoding/decoding method from Dolby Digital, DTS Digital also provides up to five discrete main channels, plus an LFE channel.	<ul style="list-style-type: none"> • DTS 1/0/.0 or .1, 2/0/.0 or .1, 3/0/.0 or .1, 3/1/.0 or .1, 2/2/.0 or .1, 3/2/.0 or .1 • DTS-ES Matrix (played as 5.1) • DTS-ES Discrete (played as 5.1)
DTS-HD	DTS-HD is a high-definition audio format that complements the high-definition video found on Blu-ray Disc and HD-DVD discs. It is transmitted using a DTS core with high-resolution extensions. Even when only DTS 5.1 surround sound is desired (or available, if the multizone system is in use), the higher capacity of high-resolution discs serves up DTS at twice the bit rate used on DVD-Video discs.	<ul style="list-style-type: none"> • Blu-ray Disc or HD-DVD discs encoded with DTS-HD modes, delivered via HDMI connection
DTS-HD Master Audio	DTS-HD Master Audio technology delivers bit-for-bit reproductions of studio master recordings for an incredibly accurate performance.	<ul style="list-style-type: none"> • Blu-ray Disc or HD-DVD discs encoded with DTS-HD Master Audio technology, delivered via HDMI connection
DTS Stereo	Delivers a 2-channel downmix of DTS Digital materials or presents a matrix-encoded surround presentation.	<ul style="list-style-type: none"> • DTS 1/0/.0 or .1, 2/0/.0 or .1, 3/0/.0 or .1, 3/1/.0 or .1, 2/2/.0 or .1, 3/2/.0 or .1 • DTS 96/24 • DTS-ES Matrix
Logic 7 Mode Group	A Harman proprietary technology, Logic 7 technology enhances two-channel and matrix-encoded recordings by deriving separate information for the surround back channels. It provides more accurate placement of sound, improves panning and expands the sound field, even when used with 5.1-channel systems. Logic 7 technology uses 96kHz processing and is available in 5.1 mode. Three variants are available.	See below
Logic 7 Movie	Especially suited to two-channel sources containing Dolby Surround or matrix encoding, Logic 7 Movie mode increases center-channel intelligibility.	<ul style="list-style-type: none"> • Analog (two-channel) • Tuner • PCM (32kHz, 44.1kHz, 48kHz, 96kHz)
Logic 7 Music	The AVR is programmed at the factory to default to this mode for two-channel signals. Logic 7 Music mode is well suited to conventional two-channel music recordings.	<ul style="list-style-type: none"> • Analog (two-channel) • Tuner • PCM (32kHz, 44.1kHz, 48kHz, 96kHz)
Logic 7 Game	Use Logic 7 Game mode to enhance enjoyment of video-game consoles.	<ul style="list-style-type: none"> • Analog (two-channel) • Tuner • PCM (32kHz, 44.1kHz, 48kHz, 96kHz)
5-Channel Stereo	Useful for parties, the left- and right-channel information is played through both the front and surround speakers on each side, while the center speaker plays a summed mono mix.	<ul style="list-style-type: none"> • Analog (two-channel) • Tuner • PCM (32kHz, 44.1kHz, 48kHz, 96kHz)
2-Channel Stereo	Turns off all surround processing and plays a pure 2-channel signal or a downmix of a multichannel signal. The signal is digitized and bass management settings are applied, making it appropriate when a subwoofer is used.	<ul style="list-style-type: none"> • Analog (two-channel; DSP downmix available for multichannel) • Tuner • PCM (32kHz, 44.1kHz, 48kHz, 96kHz)

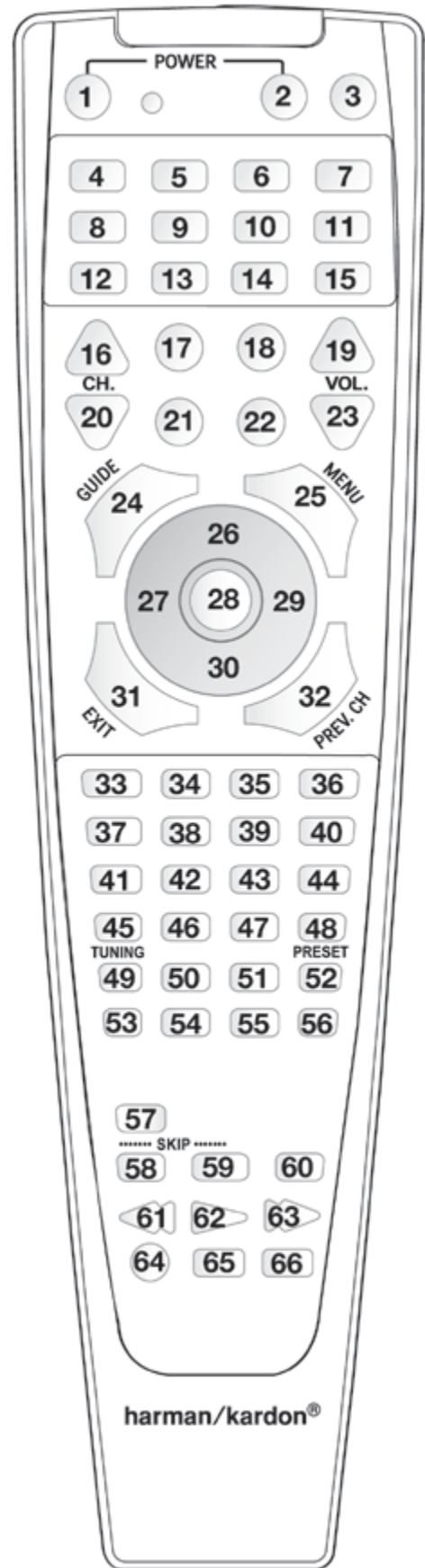

Refer to the numbered buttons when using the Remote Control Function List

Table A10 – Remote Control Function List

No.	Button Name	AVR Function	DVD	CD/CD-R	Tape	VCR (VID1)	TiVo® (VID1)	DMC (VID 1/ HDMI 1/2/3/4)	CBL (VID2)	SAT (VID2)	iPod (in The Bridge IIIP)	HDMI 1/2/3/4
01	Power On	Power On	Power On	Power On		Power On	Power On/Off	Power On	Power On	Power On	Power On	Power On
02	Power Off	Power Off	Power Off	Power Off		Power Off	TV Power	Power Off	Power Off	Power Off	Power Off	Power Off
03	Mute	Mute	Mute	Mute	Mute	Mute	Mute	Mute	Mute	Mute	Mute	Mute
04	AVR	AVR Select	AVR Select	AVR Select	AVR Select	AVR Select	AVR Select	AVR Select	AVR Select	AVR Select	AVR Select	AVR Select
05	DVD	DVD Select	DVD Select	DVD Select	DVD Select	DVD Select	DVD Select	DVD Select	DVD Select	DVD Select	DVD Select	DVD Select
06	VID 1 (VCR)	Video 1 Select	VCR Select	VCR Select	VCR Select	VCR Select	VCR Select	VCR Select	VCR Select	VCR Select	VCR Select	VCR Select
07	HDMI 1	HDMI 1 Select	HDMI 1 Select	HDMI 1 Select	HDMI 1 Select	HDMI 1 Select	HDMI 1 Select	HDMI 1 Select	HDMI 1 Select	HDMI 1 Select	HDMI 1 Select	HDMI 1 Select
08	Tape	Tape Select	Tape Select	Tape Select	Tape Select	Tape Select	Tape Select	Tape Select	Tape Select	Tape Select	Tape Select	Tape Select
09	CD	CD Select	CD Select	CD Select	CD Select	CD Select	CD Select	CD Select	CD Select	CD Select	CD Select	CD Select
10	VID 2 (CBL/SAT)	Video 2 Select	CBL/SAT Select	CBL/SAT Select	CBL/SAT Select	CBL/SAT Select	CBL/SAT Select	CBL/SAT Select	CBL Select	SAT Select	CBL/SAT Select	CBL/SAT Select
11	HDMI 2	HDMI 2 Select	HDMI 2 Select	HDMI 2 Select	HDMI 2 Select	HDMI 2 Select	HDMI 2 Select	HDMI 2 Select	HDMI 2 Select	HDMI 2 Select	HDMI 2 Select	HDMI 2 Select
12	AUX	Aux Select	Aux Select	Aux Select	Aux Select	Aux Select	Aux Select	Aux Select	Aux Select	Aux Select	Aux Select	Aux Select
13	Bridge	Bridge Select	Bridge Select	Bridge Select	Bridge Select	Bridge Select	Bridge Select	Bridge Select	Bridge Select	Bridge Select	Bridge Select	Bridge Select
14	HDMI 4	HDMI 4 Select	HDMI 4 Select	HDMI 4 Select	HDMI 4 Select	HDMI 4 Select	HDMI 4 Select	HDMI 4 Select	HDMI 4 Select	HDMI 4 Select	HDMI 4 Select	HDMI 4 Select
15	HDMI 3	HDMI 3 Select	HDMI 3 Select	HDMI 3 Select	HDMI 3 Select	HDMI 3 Select	HDMI 3 Select	HDMI 3 Select	HDMI 3 Select	HDMI 3 Select	HDMI 3 Select	HDMI 3 Select
16	Sleep/CH+	Sleep	Audio			Channel +	Channel +	Audio	Channel +	Channel +	Channel +	Channel +
17	Test Tone	Test Tone						Find				
18	AM/FM	Tuner Select	Tuner Select	Tuner Select	Tuner Select	Tuner Select	Tuner Select	Tuner Select	Tuner Select	Tuner Select	Tuner Select	Tuner Select
19	Vol Up	Volume Up	Volume Up	Volume Up		Volume Up	Volume Up	Title	Volume Up	Volume Up	Volume Up	Volume Up
20	CH-		Disc Menu or Title	CD-R Select		Channel -	Channel -	Info	Channel -	Channel -	Channel -	Channel -
21	OSD	OSD		Program		OSD	Live TV		OSD	OSD	OSD	OSD
22	TV		TV/DVD or V. OFF	Input Select		TV/VCR	TV Input		TV/CBL	TV/SAT	TV/VCR	TV/Video
23	Vol Down	Volume Down	Volume Down	Volume Down		Volume Down	Volume Down		Volume Down	Volume Down	Volume Down	Volume Down
24	CH./Guide	Channel Trim	Title or Disc Menu	Continuous Play			Guide	Disc Menu	Info/Guide	Info/Guide		Guide
25	Speaker Menu	Speaker Adjust	Menu or Setup	Intro Scan		Menu	Menu	Setup	Menu	Menu	Menu	Menu
26	Up	Move/Adjust Up	Up			Up	Up	Up	Up	Up	Up	Up
27	Left	Move/Adjust Left	Left			Left	Left	Left	Left	Left	Left	Left
28	OK	OK	Enter			Enter	Select	Enter	Enter	Enter	Enter	Set/Enter
29	Right	Move/Adjust Right	Right			Right	Right	Right	Right	Right	Right	Right
30	Down	Move/Adjust Down	Down			Down	Down	Down	Down	Down	Down	Down
31	Digital/Exit	Digital Input Select	Open/Close				Return/Exit	Open/Close				
32	Delay/Prev. Ch.	Delay Adjust	Return or Status	Open/Close				Status	Prev Channel	Prev Channel	Prev Channel	Prev Channel
33	1	1	1	1		1	1	1	1	1	1	1
34	2	2	2	2		2	2	2	2	2	2	2
35	3	3	3	3		3	3	3	3	3	3	3

Table A10 – Remote Control Function List (cont.)

No.	Button Name	AVR Function	DVD	CD/CD-R	Tape	VCR (VID1)	TiVo® (VID1)	DMC (VID 1/ HDMI 1/2/3/4)	CBL (VID2)	SAT (VID2)	iPod (in The Bridge III P)	HDMI 1/2/3/4
36	4	4	4	4		4	4	4	4	4	4	4
37	5	5	5	5		5	5	5	5	5	5	5
38	6	6	6	6		6	6	6	6	6	6	6
39	7	7	7	7		7	7	7	7	7	7	7
40	8	8	8	8		8	8	8	8	8	8	8
41	Tun-M	Tuner Mode	Chapter+ or Zoom	Repeat				Zoom				
42	9	9	9	9		9	9	9	9	9	9	9
43	0	0	0	0		0	0	0	0	0	0	0
44	Memory	Memory	Audio or Playlist	Time				Source (DMC250 only)				
45	Tuning Up	Tuning Up	Next Chapter	Track Direct		Cancel			PPV	Cancel	Sleep	
46	Direct	Direct Tuner Entry	Angle	Random Play				Angle	FAV	FAV		Angle/FAV
47	Clear	Clear	Clear	Clear		Clear	Clear	Clear	Bypass	Next		
48	Preset Up	Preset Tune Up	Slow Forward	+10					Music	Alt		
49	Tuning Down	Tuning Down	Prev Chapter	Track Increment								
50	Tone	Tone mode						V-off				
51	D.Skip (AVR 1650); RDS (AVR 165)	D.Skip (AVR 1650); RDS (AVR 165)	Disc Skip	Disc Skip			Skip	Play Mode				
52	Preset Down	Preset Tune Down	Slow Rev									
53	M1	Macro 1	Macro 1	Macro 1	Macro 1	Macro 1	Macro 1	Macro 1	Macro 1	Macro 1	Macro 1	Macro 1
54	M2	Macro 2	Macro 2	Macro 2	Macro 2	Macro 2	Macro 2	Macro 2	Macro 2	Macro 2	Macro 2	Macro 2
55	M3	Macro 3	Macro 3	Macro 3	Macro 3	Macro 3	Macro 3	Macro 3	Macro 3	Macro 3	Macro 3	Macro 3
56	M4	Macro 4	Macro 4	Macro 4	Macro 4	Macro 4	Macro 4	Macro 4	Macro 4	Macro 4	Macro 4	Macro 4
57	Night	Night Mode Select	Subtitle On/Off	CDP Select				Subtitle				
58	Skip Down	Skip – (DVD)	Step –	Skip –		Scan –	Thumbs Down	Skip –	Skip – (DVD)	Skip – (DVD)	Skip –	
59	Skip Up	Skip + (DVD)	Step +	Skip +		Scan +	Thumbs Up	Skip +	Skip + (DVD)	Skip + (DVD)	Skip +	
60	Dim	Dimmer	Dimmer					Dimmer				
61	Rewind ◀◀	R. Search (DVD)	R. Search	R. Search	Rewind	Rewind	R. Search	R. Search	R. Search (DVD)	R. Search (DVD)	R. Search	R. Search
62	Play ▶	Play (DVD)	Play	Play	R. Play/F. Play	Play	Play	Play	Play (DVD)	Play (DVD)	Play	Play
63	FF ▶▶	F. Search (DVD)	F. Search	F. Search	Fast Fwd	Fast Fwd	F. Search	F. Search	F. Search (DVD)	F. Search (DVD)	F. Search	F. Search
64	Record			Record	Record/Pause	Record	Record	Record				
65	Stop	Stop (DVD)	Stop	Stop	Stop	Stop	Stop	Stop	Stop (DVD)	Stop (DVD)	Stop	Stop
66	Pause	Pause (DVD)	Pause	Pause		Pause	Pause	Pause	Pause (DVD)	Pause (DVD)	Pause	Pause

Note: When any of the transport controls are pressed while the remote is in AVR or Video 2 mode, the remote will automatically switch to DVD mode, and the command will be applied to the DVD player. If you then press a button native to the original mode, e.g., Volume Down for the AVR, the remote will revert to the original mode. See *Remote-Channel Control Punch-Through*, on page 24, for more information.

Table A11 – Remote Control Product Codes: TV

TV Manufacturer/Brand	Setup Code Number
ADMIRAL	192
ANAM	045 106 109 112 122
AOC	037 122 123 128
AUDIOVOX	012
BLAUPUNKT	084
BROKSONIC	205 206
CITIZEN	045 123 128 132
CONTEC	045
CRAIG	045 157 158 159
CROWN	045 132
CURTIS MATHES	123 128 132
DAEWOO	045 087 102 105 106 108 111 114 116 119 127 128 132
DAYTRON	128 132
DYNATECH	063
DYNEX	014
ELECTROHOME	115 132
EMERSON	045 123 128 132 139 157 158 159 162 205
FUNAI	045
FUJITSU	041 042
FUTURETECH	045
GE	029 087 121 123 128 133 145 159 163
GRUNDIG	193
HALLMARK	128
HARMAN KARDON	201
HITACHI	123 128 132 144 147
HYTEK	016
INKEL	120
JC PENNEY	115 123 128 132 145
JENSEN	019
JVC	079 087 134
KEC	045
KLH	006

TV Manufacturer/Brand	Setup Code Number
KTV	045 123 132 162
LG/GOLDSTAR	002 013 101 110 122 128 132
LLOYTRON	172 173
LODGENET	069
LXI	077 145 148
MAGNAVOX	030 040 123 128 132 145 148
MARANTZ	115 123 148
MEMOREX	069 128
METZ	084
MGA	115 123 128
MITSUBISHI	077 115 123 128 160 167 168
MTC	175 176
NATIONAL	148 177 179 180 181 182
NEC	010 115 121 123 125
OLEVIA	007
OPTONICA	007
ORION	207 208 209 210 211
PANASONIC	087 148 169
PHILCO	045 115 123 128 132 148
PHILIPS	033 034 035 036 123 128 132 145 148
PIONEER	024 123 128
POLAROID	003 004 005 006 043
PORTLAND	128 132
PROSCAN	133
PROTON	008 059 122 128 132 165
QUASAR	032 087
RADIO SHACK	045 128 132 180 196 197
RCA	021 115 123 128 133 145 161 163
REALISTIC	045 167 196
RUNCO	044 046 152 153
SAMPO	059 123 128
SAMSUNG	020 022 124 128 132 145

Table A11 – Remote Control Product Codes: TV (cont.)

TV Manufacturer/Brand	Setup Code Number
SANYO	026 054
SCOTT	045 128 132
SEARS	128 132 145
SHARP	077 128 132
SIEMENS	084
SIGNATURE	069
SONY	028 031 117 130 136 194 212
SOUNDESIGN	045 128
SYLVANIA	025 123 128 145 148
SYMPHONIC	184
TANDY	077
TATUNG	063
TECHNICS	181
TECHWOOD	128
TEKNIKA	045 069 115 123 128 132
TELERENT	069
TERA	156
THOMSON	190 191
TIVO	051 052 and See Table A12
TMK	128
TOSHIBA	063 129 202
TOTEVISION	132
VIDEO CONCEPTS	160
VIDTECH	128
VIEWSONIC	011 038 039 047
VIZIO	001 002
WARDS	069 128 132 148
WESTINGHOUSE	017 018 023
YAMAHA	123 128
YORK	128
ZENITH	069 090

Table A12 – Remote Control Product Codes: VCR

VCR Manufacturer/Brand	Setup Code Number
AIWA	040
AKAI	048 108 109 126
APPLE TV	016
AUDIO DYNAMICS	018 048
BROKSONIC	110 147
CANON	135 140
CAPEHART	094
CITIZEN	134
CRAIG	045 116
DAEWOO	017 094 104
DAYTRON	094
DBX	018 048
DYNATECH	040
EMERSON	013 040 042 110 112
FISHER	017
FUNAI	040
GE	076 095 124
HARMAN KARDON	002 003 018 049
HITACHI	040 048
JC PENNEY	018 045
JENSEN	048
JVC	018 048 111 132
KENWOOD	020 048
LG/GOLDSTAR	018 107
LLOYD	040
LXI	020 040
MAGNAVOX	040
MARANTZ	018
MEMOREX	017 020 040 052 053 054 076 142
MGA	049
MITSUBISHI	049 131
MULTITECH	040

Table A12 – Remote Control Product Codes: VCR (cont.)

VCR Manufacturer/Brand	Setup Code Number
SYLVANIA	040
SYMPHONIC	040
TANDY	017 040
TEAC	040 048
TEKNIKA	040
THOMAS	040
TiVo	004 005 006 007 008 009 011 012
TMK	013
TOSHIBA	112 155
TOTEVISION	045
UNITECH	045
VECTOR RESEARCH	018
VIDEO CONCEPTS	018 040
VIDEOSONIC	045
WARDS	040 045 112
YAMAHA	018 040 048
ZENITH	040 050 076 083

Table A13 – Remote Control Product Codes: CD

CD Manufacturer/Brand	Setup Code Number
ADCOM	063 069
AIWA	072 111 118 156 170
AKAI	050 177 184
AUDIO TECHNICA	053
AUDIOACCESS	125
AUDIOFILE	211
BSR	044
CALIFORNIA AUDIO	109
CAPETRONIC	070
CARRERA	087
CARVER	136 140 141 143 144 145 185 186
CASIO	117 166

Table A13 – Remote Control Product Codes: CD (cont.)

CD Manufacturer/Brand	Setup Code Number
CLARINETTE	166
DENON	187 188 213
EMERSON	052 093 108
FISHER	055 095
FUNAI	126
GE	164
HAITAI	099 214
HARMAN KARDON	001 002 025 054 190
HITACHI	093
INKEL	216
JC PENNEY	098 147
JENSEN	153
JVC	176 195 196
KENWOOD	030 062 078 079 148 151 176 178 181
LG/GOLDSTAR	016 087
LOTTE	108
LUXMAN	077 102
LXI	164
MAGNAVOX	039 113
MARANTZ	058 084 191 192 193
MCINTOSH	194
MCS	080 098
MITSUMI	152
MODULAIRE	166
NAD	013 074 197 198
NAKAMICHI	199 200 201
NEC	069
NIKKO	053 055
ONKYO	037 038 045 046 171 175 202 203
OPTIMUS	065 089 091 092 099 104 212
PANASONIC	075 109 119 158 183 204
PHILIPS	039 138 149 209
PIONEER	071 094 100 112 123 131 161 162 215

Table A13 – Remote Control Product Codes: CD (cont.)

CD Manufacturer/Brand	Setup Code Number
PROTON	210
RADIO SHACK	126 166 213
RCA	024 081 093 150
REALISTIC	058 093 095 104 105 108 164 166
SANSUI	047 081 134 157 172
SANYO	033 082 095
SCOTT	108
SHARP	058 105 114 151 159 167 180 181
SHERWOOD	003 041 058 105 133
SONY	103 115 116 118 132 139 163 205 206 207 208 212 217
SOUNDSTREAM	124
SYMPHONIC	059 110
TAEKWANG	177
TEAC	011 058 085 086 106 107 110 121 137 146 154
THETA DIGITAL	039
TOSHIBA	013 074 097 151 155 173
VECTOR RESEARCH	087
VICTOR	120 130
WARDS	095
YAMAHA	019 031 053 061 135 169
YORK	166

Table A14 – Remote Control Product Codes: DVD

DVD Manufacturer/Brand	Setup Code Number
APEX DIGITAL	061
DENON	019 020 051
GE	004 103
HARMAN KARDON	001 002 003
JVC	006
LG/GOLDSTAR	005 010 055 064 066
MAGNAVOX	056
MARANTZ	059

Table A14 – Remote Control Product Codes: DVD (cont.)

DVD Manufacturer/Brand	Setup Code Number
MITSUBISHI	023
NAD	062
ONKYO	009 048
PANASONIC	008 024 030 044
PHILIPS	016 056
PIONEER	018 027 041 065
PROCEED	060
PROSCAN	004 103
RCA	004 103
SAMSUNG	017 053 054
SHARP	028
SONY	011 012 015 043 045
THOMSON	004 103
TOSHIBA	009 058 067
YAMAHA	030 063
ZENITH	005 055 064

Table A15 – Remote Control Product Codes: SAT

SAT Manufacturer/Brand	Setup Code Number
BIRDVIEW	425
CHANNEL MASTER	320 321 325 361
CHAPARRAL	315 316 451
CITOH	360
DIRECTV	309 310 314
DISH NETWORK	364
DRAKE	313 317 318 413 481
DX ANTENNA	331 352 379 483
ECHOSTAR	364 395 397 452 453 463 477 478 484 485
ELECTRO HOME	392
FUJITSU	324 329 334
GENERAL INSTRUMENT	303 311 323 365 403 454 468 474
HITACHI	304 455
HOUSTON TRACKER	463

Table A15 – Remote Control Product Codes: SAT (cont.)

SAT Manufacturer/Brand	Setup Code Number
HUGHES	305 306 437 489
JANIEL	366
JERROLD	454 468 484
LEGEND	453
MACOM	317 365 369 370 371
MAGNAVOX	461 473
MEMOREX	453
MITSUBISHI	307
MOTOROLA	312 319
NEXTWAVE	423
NORSAT	373
OPTIMUS	466
PACE	328 487
PANASONIC	353 366 457 469
PANSAT	420
PERSONAL CABLE	418
PHILIPS	375
PICO	407
PRESIDENT	381 404
RCA	301 358 439 458 465 490
REALISTIC	349 480
SAMSUNG	322 326 442
SATELLITE SERVICE CO	335 388
SCIENTIFIC ATLANTA	339 356
SONY	362 405
STAR CHOICE DBS	459
STARCAST	347
SUPER GUIDE	327 423
TELECOM	330 333 390 391 393 409
TOSHIBA	302 426 460 461 462 470
UNIDEN	323 332 348 349 350 351 354 355 381 383 389 403 466 479 480
ZENITH	359 384 385 387 394 419 488

Table A16 – Remote Control Product Codes: Tape

Cassette Deck Manufacturer/Brand	Setup Code Number
HARMAN KARDON	001

Table A17 – Remote Control Product Codes: Cable

Cable Manufacturer/Brand	Setup Code Number
ABC	001 011
ALLEGRO	111
AMERICAST	212
ARCHER	112
BELCOR	113
CABLE STAR	033 113
CITIZEN	111
COMCAST	007
DIGI-LINK	114
EAGLE	186
EASTERN	066 070
EMERSON	112
GENERAL INSTRUMENT	001 011 017 096 097 210
GC ELECTRONICS	113
GEMINI	032 060
HAMLIN	056 099 100 101 117 175 208
HITACHI	001 188
JASCO	111
JERROLD	001 002 011 017 073 096 097 162 188 210
LINSAY	118
MACOM	191
MAGNAVOX	017 019 068
MOVETIME	035 039
NSC	035 190
OAK	197 220
PACE	179
PANASONIC	053 176 177 189 214
PANTHER	114

Table A17 – Remote Control Product Codes: Cable (cont.)

Cable Manufacturer/Brand	Setup Code Number
PHILIPS	013 019 020 085 090
PIONEER	001 041 119 171 209 215 216
RADIO SHACK	111 112 213
RCA	053 214
RECOTON	116
REGAL	056 099 100 101 208
REMBRANDT	032
SAMSUNG	003 072 186
SCIENTIFIC ATLANTA	183 203 221 222
SEAM	121
SIGNATURE	001 188
SPRUCER	053 081 177 189
STARCOM	002 011 163
STARGATE	120
TANDY	024
TELECAPATION	028
TEXSCAN	036
TFC	122
TIVO	029 030 and See Table A12
TOCOM	170 205
UNITED CABLE	011
UNIVERSAL	033 034 039 042 113
VIDEOWAY	124 211
VIEWSTAR	019 025 053 086 089 190
ZENITH	065 125 211 219



HARMAN

HARMAN Consumer, Inc.
8500 Balboa Boulevard, Northridge, CA 91329 USA

© 2011 HARMAN International Industries, Incorporated. All rights reserved.

Harman Kardon and Logic 7 are trademarks of HARMAN International Industries, Incorporated, registered in the United States and/or other countries. EzSet/EQ is a trademark of HARMAN International Industries, Incorporated.

Apple, iPhone, iPod, iPod touch, iPod nano and iPod classic are trademarks of Apple Inc., registered in the U.S. and other countries.

Blu-ray Disc is a trademark of the Blu-ray Disc Association.

CEA is a registered trademark of the Consumer Electronics Association.

Manufactured under license from Dolby Laboratories. Dolby, the double-D symbol and Pro Logic are registered trademarks of Dolby Laboratories. MLP Lossless is a trademark of Dolby Laboratories.

Manufactured under license under U.S. Patent #'s 5,451,942; 5,956,674; 5,974,380; 5,978,762; 6,226,616; 6,487,535; 7,003,467 and other U.S. and worldwide patents issued and pending. DTS is a registered trademark, and DTS 96/24, DTS-HD and DTS-HD Master Audio are trademarks, of DTS, Inc. © 1996-2007 DTS, Inc. All Rights Reserved.

HDMI, the HDMI logo and High-Definition Multimedia Interface are registered trademarks of HDMI Licensing LLC in the United States and other countries.

TiVo is a registered trademark of TiVo Inc.

Features, specifications and appearance are subject to change without notice.

harman/kardon
by HARMAN

www.harmankardon.com