

harman/kardon

hk 503

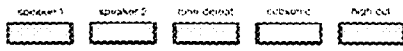

DC COUPLED ULTRAWIDEBAND INTEGRATED AMPLIFIER

HEADPHONES

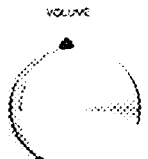
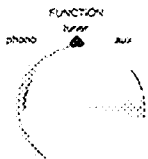
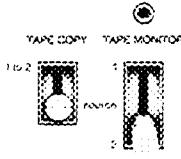

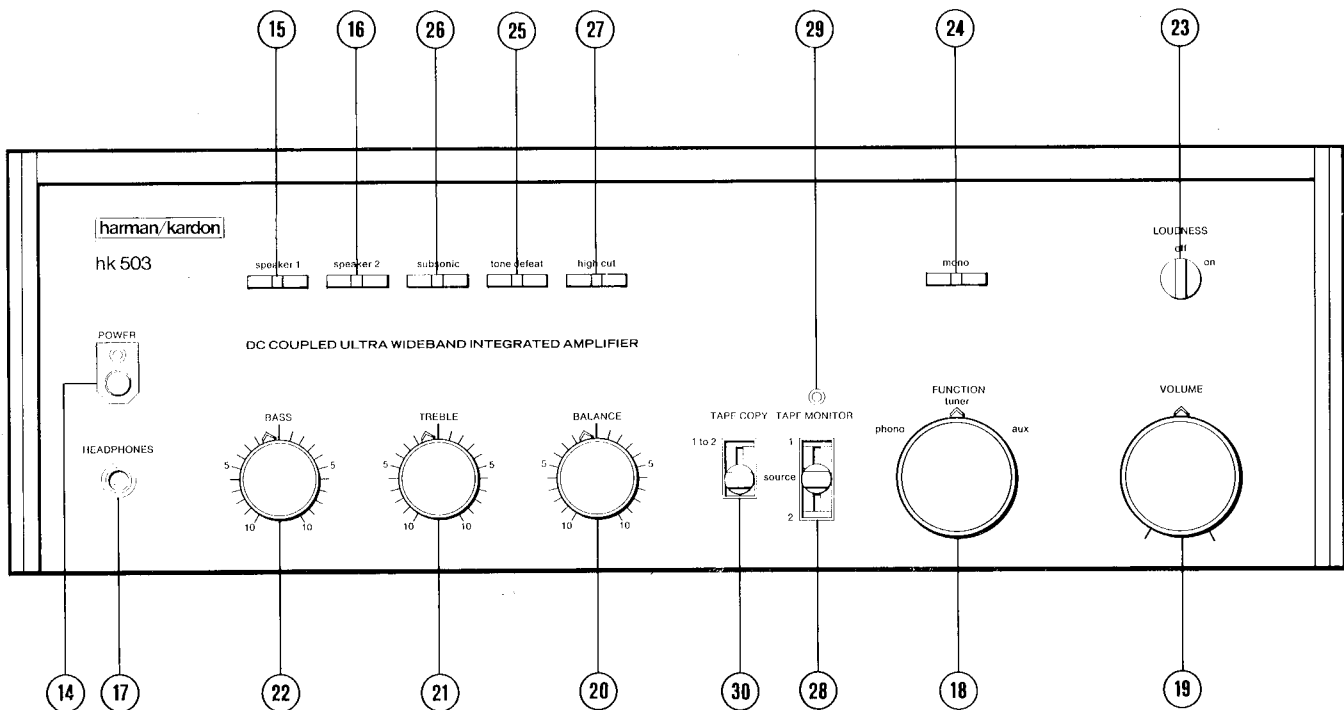
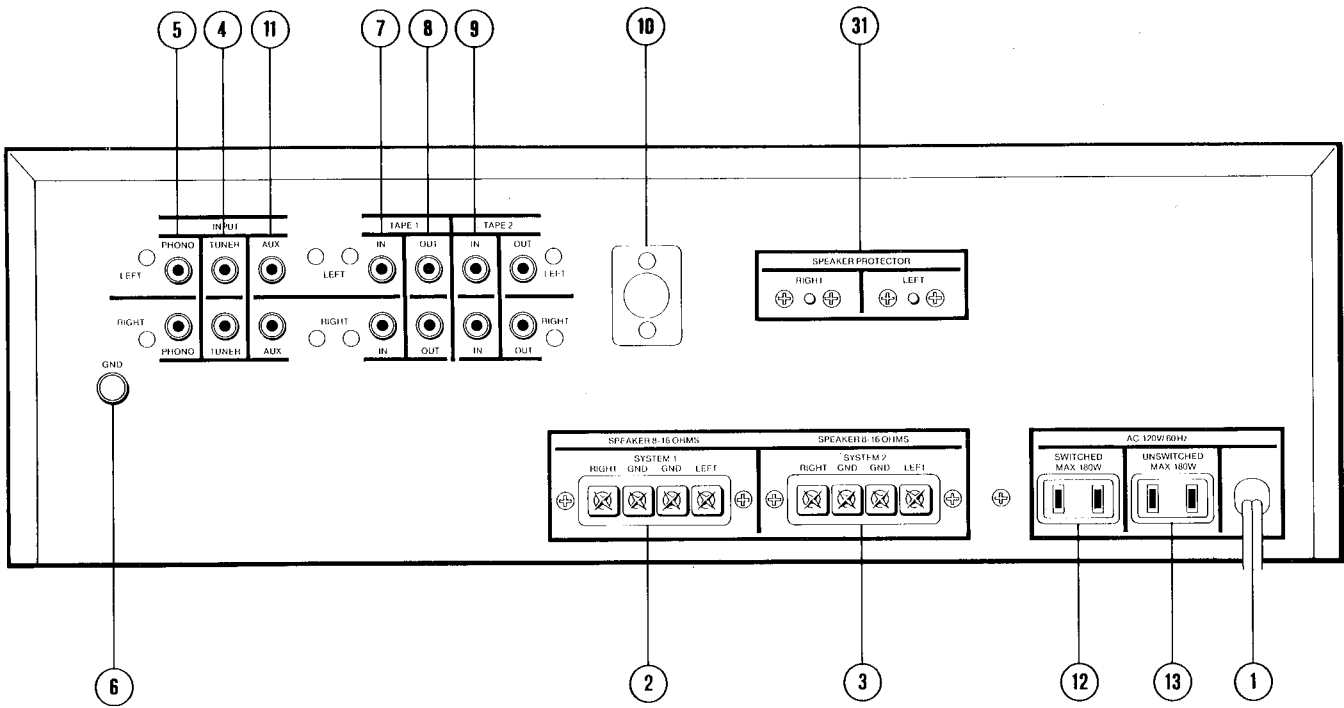

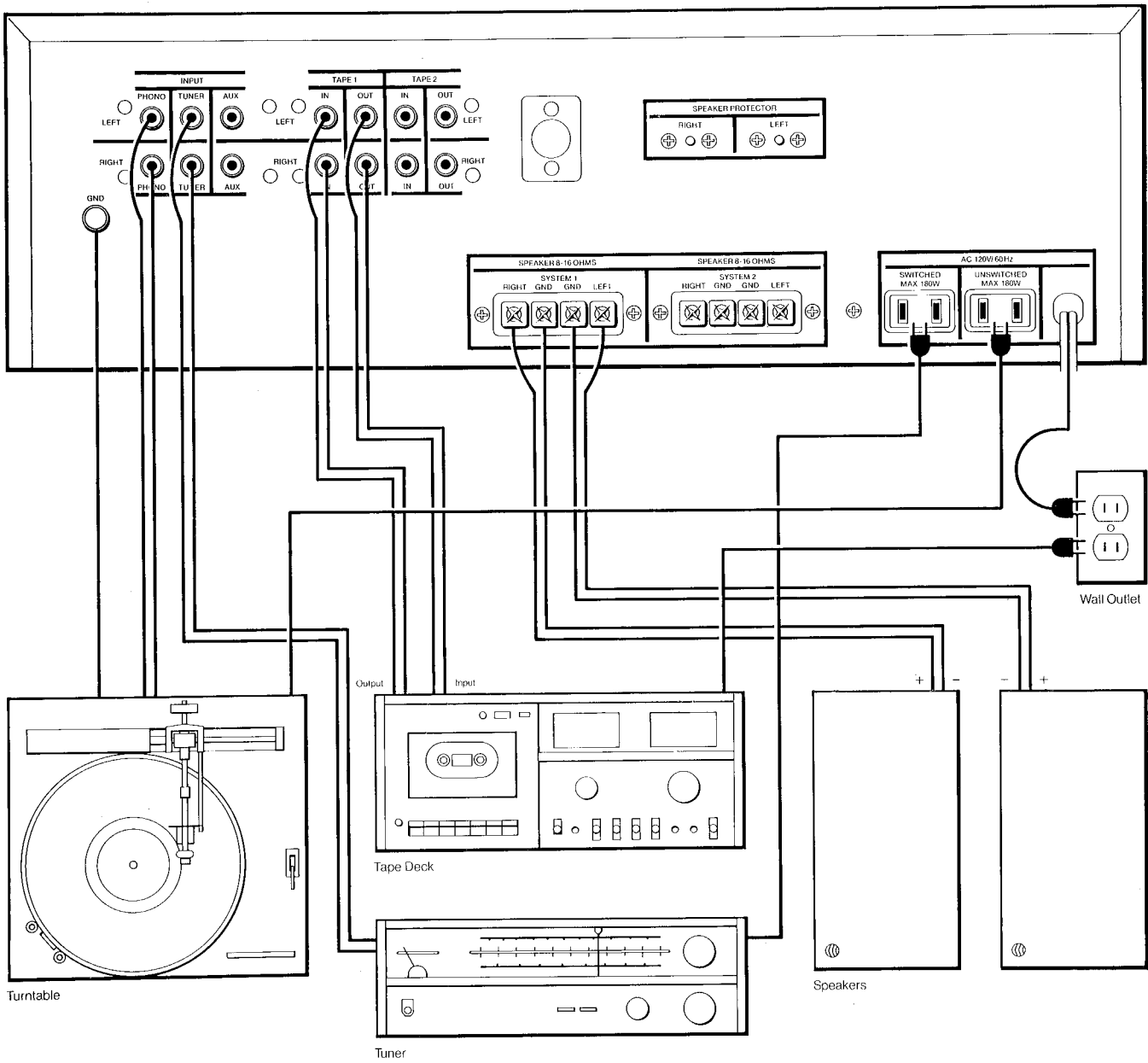

Turntable

Tape Deck

Tuner

Speakers

Wall Outlet

OWNER'S MANUAL: hk503

To ensure continuing high performance, read this manual carefully before you connect and operate your hk503 amplifier.

CONNECTIONS

For the moment, leave the power cord (1) of the hk503 unconnected. Put the unit on the shelf or table where it will be installed. Leave enough working space so you can make connections easily.

All amplifiers require adequate ventilation. The hk503 should not be installed on a cushion or rug, and a minimum of two inches' clearance should be provided above and behind.

Speaker Compatibility

The hk503 has been designed to drive a single pair of 4 ohm speakers or up to two pairs of 8- or 16-ohm speakers.

Connecting Speakers

Use two-conductor stranded wire to connect your speakers to the amplifier. Eighteen gauge lamp cord (zip cord) is satisfactory, but a heavier gauge (16 or 14 gauge) is preferable, especially for distances over 25 feet.

Cut two segments of wire long enough to reach each speaker. Separate the conductors at each end of the wire segments for a length of two or three inches. Then carefully remove about one-quarter inch of insulation from each free end. Twist the strands of each conductor so they are smooth and tight with no loose strands.

Lamp cord usually provides a "code" that differentiates the two conductors. A conductor may be coded by a rib, sharp corner, or indentations molded along the length of the insulation. In some cases, a thin colored thread is molded inside the insulation of one conductor. In others, one conductor is darker than the other, or the insulation of each conductor is of a different color.

Connect the bare ends of one segment of lamp cord to your right speaker as follows: Connect the coded conductor to the speaker's positive ("+") terminal, and the uncoded conductor to negative ("-"). (The "+" and "-" markings are in general use, although some speakers use other labeling

systems, such as "1" and "2", "A" and "B", and so on.) Find the appropriate row of speaker connectors on the amplifier marked SPEAKER SYSTEM 1 (2). Push in on the red plastic head of the connector marked RIGHT to reveal an opening beneath. Insert the bare end of the coded conductor into the opening. Release the connector. The conductor should now be locked firmly into place. Insert the uncoded conductor into the adjacent black connector marked GND.

Repeat the procedure for the left speaker, taking care to observe the coding of the conductors as described for the right speaker. If the code is followed as described, your speakers will be connected "in phase", which is important for solid bass and precise lateral location of the sound source. To connect a second pair of speakers, repeat the procedure for the right and left speakers of the second pair, using the amplifier terminals marked SYSTEM 2 (3).

NOTE: This amplifier may be used with either 4, 8 or 16 ohm loudspeakers, connected in the following manner:

8 and 16 ohm impedance: single pair of loudspeakers connect to either system 1 or 2. Two pair of loudspeakers connect to both system 1 and 2.

4 ohm impedance: use single pair of loudspeakers only, and connect to either system.

Connecting Your Tuner

Tuners are supplied with their own signal cables. Connect the left and right outputs of the tuner to the left and right TUNER jacks (4) of the amplifier.

Connecting Your Turntable

The PHONO inputs (5) have been designed to operate with a high-quality magnetic phono cartridge. Do not use a ceramic phono cartridge. Turntables are

supplied with their own signal cables. Consult the turntable owner's manual and determine which cable is for the left channel and which for the right. Insert the plug of the signal cables into the jacks on the receiver marked PHONO, LEFT and RIGHT. If the turntable has a separate ground wire, connect it to the knurled lug on the amplifier marked GND (6).

Tape Deck Connections

To connect a tape deck, first connect the line outputs of the tape deck to the left and right TAPE 1 IN jacks (7) of the amplifier. Then connect the left and right TAPE 1 OUT jacks (8) of the hk503 to the line inputs of the tape deck. To connect a second tape deck, repeat the procedure using the TAPE 2 IN and TAPE 2 OUT jacks (9) of the hk503. Where applicable, a standard DIN socket (10) is provided for use with tape decks equipped with a DIN connector.

Time Delay And Signal Processing

In addition to providing connections for tape decks, the TAPE IN and OUT jacks of the hk503 can be used to connect signal processors such as equalizers, noise reduction units, and dynamic range enhancers. In particular, the TAPE 2 OUT jacks can be used to connect a time delay system. In this configuration, the TAPE 2 OUT jacks provide the input for a time delay unit, which is then connected to separate amplifiers and speakers.

Auxiliary Input Connection

The AUX inputs (11) provide for facilities to connect high level signal sources. These include tuners, additional tape decks (for playback only), the audio output of a TV set or special tuners for long wave, marine, aircraft, or citizen's band.

AC Convenience Outlets

The AC outlets on the rear panel provide connections for a turntable, tape deck, or other equipment drawing as much as 180

watts of current. One outlet is marked SWITCHED (12) and is "live" only when the amplifier is switched on.

The other, marked UNSWITCHED (13) provides power whenever the receiver itself is connected to a "live" AC outlet. Automatic turntables and changers should always be plugged into the UNSWITCHED outlet to allow the automatic function to complete its cycle, even after the amplifier has been turned off.

Power Connection

If you have completed all the connections you wish to make, you are now ready to place the amplifier in its permanent position and plug its power line cord (1) into an AC outlet.

OPERATION

Power

The POWER switch (14) is located on the left side of the front panel, and is "on" in the depressed position.

Speaker Selection and Headphones

The SPEAKER 1 (15) and SPEAKER 2 (16) switches select the pair of speakers to be played. When either switch is depressed, the corresponding pair of speakers is activated.

The front panel HEADPHONES jack (17) accepts headphones for personal listening. Headphones may be used simultaneously with speakers if desired.

Function Selection

Use the FUNCTION control (18) to select the desired program source.

To Play Records

Set the FUNCTION control (18) to PHONO, and activate your turntable.

If you hear hum at average listening levels, turn the POWER switch (14) off and ensure that PHONO (5) and GND (6) connections are secure.

To Play Broadcasts

Set the FUNCTION (18) to TUNER, activate your tuner, and tune in the desired station.

Auxiliary Source

You can listen to the auxiliary source that you have connected by setting the FUNCTION control (18) to AUX.

To Play Back Tapes

The TAPE MONITOR switch (28) admits programs from any line-level source (usually a tape deck) connected to the TAPE IN jacks. When you wish to play back a tape, set the TAPE MONITOR switch to TAPE 1 or TAPE 2. When the switch is set to TAPE 1 or TAPE 2 the red LED (29) above the switch will glow. Note that as long as the switch is set to TAPE 1 or TAPE 2, it will switch off the sound from any other component, regardless of the position of the FUNCTION control.

To Record Tapes

The TAPE OUT jacks allow you to record program material from any source selected by the FUNCTION control. The VOLUME and BALANCE controls, and the various tone controls do not affect the signal at the TAPE OUT jacks. Hence you can change the settings of these controls without altering a tape recording in progress.

If your tape deck has a separate monitor head, you can use the TAPE MONITOR feature of the hk503 to compare the original source with the recording. Set the TAPE MONITOR switch (28) to the appropriate position (TAPE 1 or TAPE 2), and you will hear the recording a fraction of a second after it has been made. Return the TAPE MONITOR switch to source, and you will hear the original source.

The hk503 also provides the ability to record directly from one tape deck to another, while you listen to a separate source (such as records or FM) as the tape is being copied. With the TAPE COPY switch (30) set 1 TO 2 you can copy a tape

from deck 1 onto deck 2. At any time you may listen to tape deck 1 by setting the TAPE MONITOR switch (28) to TAPE 1. When you have finished making the copy, return the TAPE COPY switch to the SOURCE POSITION.

Operating controls

To increase loudness, turn the VOLUME control (19) clockwise. The BALANCE control (20) shifts the sound to one speaker or the other.

The BASS and TREBLE controls affect the frequency balance of the program material. Their neutral positions are at 12 o'clock. Turning the TREBLE control (21) clockwise increases the high frequencies. The BASS control (22) has the same effect on the low frequencies.

When the LOUDNESS switch (23) is turned to ON, the low frequencies are boosted at low settings of the VOLUME control. This compensates for the ear's insensitivity to low frequencies at low volume levels. The switch has little effect at VOLUME settings beyond 12 o'clock.

When the MONO switch (24) is depressed, the signals from left and right channels are combined, and this monophonic signal is supplied to both speakers.

The hk503 provides three additional controls: the TONE DEFEAT switch, the SUBSONIC filter switch and the HIGH CUT filter switch. Depressing the TONE DEFEAT switch (25) eliminates the action of the BASS and TREBLE controls to allow for critical evaluation of their effect. Depressing the SUBSONIC switch (26) engages a filter to protect your speakers from inaudible low-frequency signals caused by severe record warp, acoustic feedback, or tonearm resonance effects. Depressing the HIGH CUT switch (27) reduces the extreme high frequency content of program material and the defects of noisy broadcasts, tapes, and records.

Speaker Protection

Circuit breakers on the hk503 protect your speakers from short circuits and other conditions of excessive current. If one of your speakers stops producing sound, turn the receiver off and check the speaker connections. Make sure that no wire strands touch the wrong terminal. Locate the SPEAKER PROTECTOR pushbutton (31) for that channel. Press the button in firmly and release immediately.

Maintaining Appearance

Clean the metal panel with mild, diluted detergent applied with a soft cloth or cotton swab. Never use a strong abrasive cleaner. The hk503 is a high-quality precision instrument. If the instructions in this manual are followed thoughtfully, the amplifier should provide many years of musical pleasure.